

5.31, 5.33, 5.35, 5.37 Elliptical Fitness Crosstrainer

Warning: This service manual is for use by Precor trained service providers only. If you are not a Precor Trained Servicer, you must not attempt to service any Precor Product; Call your dealer for service.

This document contains information required to perform the majority of troubleshooting, and replacement procedures required to repair and maintain this product.

This document contains general product information, software diagnostic procedures (when available), preventative maintenance procedures, inspection and adjustment procedures, troubleshooting procedures, replacement procedures and electrical block and wiring diagrams.

To move directly to a procedure, click the appropriate procedure in the bookmark section to the left of this page. You may “drag” the separator bar between this page and the bookmark section to change the size of the page being viewed.

Section One - Things You Should Know

Right, Left, Front, and Back Conventions

In this manual, right, left, front, and back are from the perspective of a user standing on the EFX5.31, 5.33, 5.35, 5.37 facing the display enclosure.

Warning and Caution Statements and General Safety Guidelines

Warning statements indicate a particularly dangerous activity. Warning statements you will find in this manual include:

- To remove power from the EFX, the power cord must be disconnected from the wall outlet. Always ensure that the EFX is unplugged from the wall outlet when you inspect or adjust the EFX, or when you isolate, remove, or replace a 5.31, 5.33, 5.35, 5.37 EFX component.
- Removing the covers exposes high voltage components and potentially dangerous machinery. Exercise extreme caution when you perform maintenance procedures with the hood removed.
- During service operations you will be very close to moving machinery and high voltage components. When you perform maintenance procedures with the covers removed, remove jewelry (especially from ears and neck), tie up long hair, remove neck ties, and do not wear loose clothing.
- Exercise caution when touching any wire or electrical component during EFX operation.

Caution statements are intended to prevent damage to the EFX as a result of the current activity. Caution statements included in this manual are listed below:

- Notice the orientation notch on the lower PCA PROM. These components must be positioned with the same notch orientation.

Safety guidelines you should know and follow include:

- Read the owner's manual and follow all operating instructions.
- Visually check the EFX before beginning service or maintenance operations. If it is not completely assembled or is damaged in any way, exercise extreme caution while operating and checking the EFX.
- When operating the EFX, do not wear loose clothing. Do not wear shoes with heels or leather soles. Check the soles of your shoes and remove any embedded stones. Tie long hair back.
- Do not rock the unit. Do not stand or climb on the handlebars, display enclosure, or cover.
- Do not set anything on the handlebars, display enclosure, or cover. Never place liquids on any part of the EFX other than a water bottle in the water bottle holder during normal

operation.

- To prevent electrical shock, keep all electrical components, such as the power cord and on/off switch away from water and other liquids.
- Do not use accessory attachments that are not recommended by the manufacturer-such attachments might cause injuries.

General Information

For the latest exploded view, part number and part pricing information, visit the Precor dealer website at "www.precor.com/connection."

Required Tools and Equipment

The following list is a summary of the tools and equipment required when you service Precor's EFX.

TOOLS

phillips and flat-head screwdrivers
standard and metric allen wrench sets
open-end wrench set
drive ratchet and ratchet set
socket drive allen set
chip puller
rubber mallet
snap ring pliers
100 ft./lb. torque wrench
300 in./lb. torque wrench
belt gauge (part # 20030-117)

EQUIPMENT

digital multimeter

Supplies

blue loctite

cable ties

Spares

data cables

Procedure 2.1 - Accessing the Hardware Validation Program

The EFX diagnostic software cycles through the following tests:

Hardware Validation

- Display Test
- Keyboard Test
- Heart Rate Test
- Machine Test
 - Brake
 - PWRB
- Crossramp Test
 - LIFT A/D
 - Auto leveling

Procedure

1. Plug the power cord into the wall outlet, then turn on the EFX with the on/off switch.

Note:

Use the **RESET** key and the ten key keypad to enter the access code.

2. With the **PRECOR EFX** banner displayed, access the diagnostic program by pressing, keys **RESET,5,1,7,6,5,7,6,1**, sequentially.

Diagram 2.1 - 5.37 Display



3. The test name **HARDWARE VALIDATION** will be displayed. Press the **OK** key to proceed to the display test.
4. The test name "**DISPLAY**" will be displayed. Press the **OK** to enter the display test or an **▲**, **▼** key to proceed to a different test.
5. Each time you press the **OK** key a different block of LED's will illuminate. Check each LED in each block to ensure that all are functioning.
6. Press and hold the **ENTER** key for several seconds to proceed to the keyboard test.
7. The test name "**KEYBOARD**" will be displayed. Press the **OK** to enter the keyboard test or an **▲**, **▼** key to proceed to a different test.
8. A graphical representation of all the keys on the keyboard will be displayed. When a key is pressed the representation of the key on the display will be turned "off". Check all of the keys on the keyboard in this manner.
9. Press and hold the **ENTER** key for several seconds to proceed to the heart rate test.
10. The test name "**HEART RATE**" will be displayed. Press the **OK** to enter the heart rate test or an **▲**, **▼** key to proceed to a different test.
11. Both the hand held heart rate and wireless heart rate function must be tested. A chest strap heart rate transmitter or a heart rate test transmitter must be used to test the wireless heart rate function.
12. When a heart rate signal is received, the unfiltered and filtered heart rates will be displayed. In addition the Polar heart rate will be displayed in the "Heart Rate" window. The red heart and the smart rate LED's will illuminate.
13. Press the **ENTER** key to proceed to the machine test.
14. The test name "**MACHINE**" will be displayed. Press the **OK** to enter the brake test or an **▲**, **▼** key to proceed to a different test.
15. The test name **BRAKE** will be displayed, press the **OK** key.
16. **PWRB** (powerbits) will be displayed. The resistance level will be displayed on the left side of the display and the corresponding power bits (duty cycle) will be displayed on the right side of the display. Initially, the power bits level will be zero, pressing the resistance **▲**, **▼** keys will change the number of power bits being applied to the eddy current system., ranging from 0 to 68 powerbits.
17. Press the **OK** key to proceed to the Lift A/D test.
18. The test name "**LIFT A/D**" will be displayed, press the **OK** key to enter the Lift A/D test.
19. Please note, on EFX's equipped with version 4.00 upper software, the EFX must be pedaled to allow the incline to activate.

20. The incline percentage will be displayed on the left and the A/D (lift calibration) number will be displayed on the right. The lift A/D number indicates the physical position of the incline and is used to calibrate the incline. The A/D number will range from 34 (level 1) to 223 (level 20).
21. Press the **OK** key to proceed to the auto-level test.
22. The test name "**AUTO-LEVEL**" will be displayed, press the OK key to enter the Lift A/D test.
23. Please note, on EFX's equipped with version 4.00 upper software, the EFX must be pedaled to allow the incline to activate
24. If the incline is not at the auto-level position it will move to the auto-level position.
25. When the incline reaches the auto-level position, the display will return to the machine test, step 13. you may then proceed to another test using the ▲, ▼ keys
26. You may press the **RESET** key at anytime in the hardware validation program to exit the hardware validation program.

Procedure 2.2 - Accessing the Diagnostics Test

Procedure

1. Plug the power cord into the wall outlet, then turn on the EFX with the on/off switch.
2. With the **PRECOR EFX** banner displayed, press keys **RESET,6,5**, sequentially.

Diagnostics Test

Odometer
Hour meter
U-Boot Software version
U-Base Software version
Lower software version
Usage Log
Error log

4. The test name **DIAGNOSTICS TEST** will be displayed. Press the **OK** key to proceed to odometer. Use the **▲**, **▼** keys to proceed to the desired display.
4. The display name "**ODOMETER**" will be displayed, press the **OK** key, the odometer value will be displayed, as total strides accumulated.
5. Press the **ENTER** key to proceed to the hour meter display.
6. The display name "**HOOR METER**" will be displayed, press the **OK** key, the hour meter will be displayed, as the total number of hours of use. Fractional parts of an hour are stored internally, the display will be truncated to the nearest full hour.
7. Press the **ENTER** key to proceed to the U-Boot software version display.
8. The display name "**U-BOOT SW**" will be displayed, press the **OK** key, the U-Boot software part number will be displayed.
9. Press the **ENTER** key to proceed to the U-Base software version display.
10. The display name "**U-BASE SW**" will be displayed, press the **OK** key, the U-Base software part number will be displayed.
11. Press the **ENTER** key to proceed to the lower software version display.
12. The display name "**LOWER SW**" will be displayed, press the **OK** key, the lower software part number will be displayed.
13. Press the **ENTER** key to proceed to the usage log.
14. The display name "**USAGE LOG**" will be displayed, press the **OK** key.
15. The program used and the time the program was used will be displayed.

16. The keys ▲, ▼ will scroll you through the list of programs that have been used.
17. Press the **ENTER** key to proceed to the error log display
18. The display name "**ERROR LOG**" will be displayed press the **OK** key.
19. The first error log entry will be displayed (**1: ERXX @ XX STRIDES XX HRS**).
20. Pressing the ▲, ▼ keys will move you through the log entries. Entry 1 will be the most recent error log entry, with each succeeding entry being older than the preceding entry.
21. If the error log is empty **NO ERRORS** will be displayed.
22. Pressing and holding the **QUICK START** key for 2 seconds will cause the prompt **CLEAR?** to be displayed, holding the **QUICK START** for an additional 2 seconds will clear all existing entries from the error log. The display will confirm that the error log has been cleared by displaying **OK**. The display will revert to the first log entry and show it as a null entry (**1: ---**). If the **QUICK START** key is not held for a minimum of 4 seconds, the error log will not be cleared.
23. Press the **RESET** key to exit the diagnostics display program.
24. Note: the error log can also be entered at any time by pressing and holding the **RESET** key for four seconds.

Procedure 2.3 - Accessing the Set User Parameters Display

Selecting United States standard units causes information to be displayed in miles. Information is displayed in kilometers if metric units are selected. After you select a measurement standard, the software accumulates and records workout information in the units of the measurement standard selected.

Procedure

1. Plug the power cord into the wall outlet, then turn on the EFX with the on/off switch.
2. With the **PRECOR EFX** banner displayed, press keys **RESET,5,6,7,1**, sequentially. On the 5.37 press the **OPTIONS** key.

Diagnostics Test

Select Units
Set Max Pause Time
Set Cool Down
Set Crossramp Auto-Level

3. The display name "**SELECT UNITS**" will be displayed, press the **OK** key to proceed to the select units display or an **▲**, **▼** key to proceed to a different display.
4. One of two measurement standards will be displayed, **U. S. Standard** or **Metric**.
5. If **U. S. Standard** is selected, weights will be in pounds and distances will be in miles. If **Metric** is selected, weights will be in kilograms and distances in kilometers.
6. Pressing any **▲**, **▼** key will toggle the units of measure between **US Standard** and **Metric**.
7. Press the **ENTER** key to save the currently displayed selection and exit the select units display.
8. The display name "**SET MAX PAUSE TIME**" will be displayed, press the **OK** key to proceed to the set max pause time display or an **▲**, **▼** key to proceed to a different display.
9. The current pause time will be displayed. Pressing any **▲**, **▼** key will increase or decrease the maximum pause time between 0 and 10 minutes.
10. Press the **ENTER** key to save the currently displayed selection and exit the set max pause time display.
11. The display name "**SET COOL DOWN TIME**" will be displayed, press the **OK** key to proceed to the set cool down time display or an **▲**, **▼** key to proceed to a different display.
12. The current cool down time will be displayed. Pressing any **▲**, **▼** key will increase or decrease the cool down time between 0 and 5 minutes.

13. Press the **ENTER** key to save the currently displayed selection and exit the set cool down time display.
14. The display name "**SET CROSSRAMP AUTO-LEVEL**" will be displayed, press the **OK** key to proceed to the set crossramp auto-level display or an **▲**, **▼** key to proceed to a different display.
15. Please note, on EFX's equipped with version 4.00 upper software, the EFX must be pedaled to allow the incline to activate.
16. The current auto-level position will be displayed. Pressing any **▲**, **▼** key will increase or decrease the auto-level position between level 0 and level 20.
17. Press the **ENTER** key to save the currently displayed selection and exit the set auto-level display.
18. Press the **RESET** key to exit the set user parameters program

Procedure 2.4 - Documenting Software Problems

When a problem is found with either the software or upper or lower PCA's, record the information listed below. If you isolated the problem to either the PROM, upper PCA, or lower PCA, include the information you have recorded with the malfunctioning PROM or PCA when you ship it to Precor.

When a problem occurs, record the following information:

- Model and serial number
- Software version numbers for upper and lower PCA's

Note:

Look at the PROM mounted on the upper PCA. A label on the PROM indicates the software version number. The part number of the PROM indicates the version number.

- User and program number running when the problem occurred
- A description of:
 - a. What happened or failed to happen.
 - b. The action taken by the user just before the problem occurred.
 - c. Problem-related information (such as how far into the program the problem occurred, the work level being used when the problem occurred, etc.).
- The frequency of occurrence.
- Contact precor technical support at 800-347-4404 to receive a return tag.

Section Three - Preventive Maintenance

Preventive maintenance measures are either scheduled or unscheduled. Scheduled preventive maintenance activities are included here so that you are aware of the preventive measures to be performed on a regular basis.

Regular Preventive Maintenance (Owner)

Cleanliness of the EFX and its operating environment will keep maintenance problems and service calls to a minimum. Precor recommends that you perform the following preventive maintenance schedule.

At the End of Each Day

Wipe down the stairarms, ramps, wheels and frame with a damp cloth.

Every Week

Wipe the surface of the electronic console with a slightly-damp sponge or soft cloth. Dry with a clean towel.

CAUTION

Keep water away from electronic components to prevent shock.

On-Site Preventive Maintenance (Service Technician)

Perform the following preventive maintenance tasks each time you are called to service a EFX:

Examine the belts for wear, cracks or other signs of deterioration and replace if necessary.

Check the LED's mounted on the upper PCA and the function keys displayed on the electronic console by performing Procedure 2.1.

Visually examine all wires and check connectors and wire connections. Secure connections and replace wiring as necessary.

Check unit operation per Section Four.

Section Four - Checking EFX Operation

This section provides you with a quick method of checking EFX operation. Check the operation of the EFX at the end of most maintenance procedures.

Procedure

1. Plug the power cord into the wall outlet and set the on/off switch in the “on” position.
2. With the **PRECOR EFX** banner displayed, press **QUICK START**.
3. Select Resistance Level 1.
4. Operate the EFX for 4–5 minutes. As you operate the EFX, concentrate on the operating sounds made by the unit. Be on the alert for unusual rubbing, hitting, grinding, or squeaking noises.
5. If the EFX makes unusual noises or the electronic display does not change appropriately, troubleshoot per section 6.4.
6. Press the **RESISTANCE ▲** key until you reach Resistance Level 10. Operate the EFX for another 2–3 minutes.
7. If the EFX resistance does not change or the operation of the EFX feels inconsistent compared with Resistance Level 1, troubleshoot per section 6.4.
8. Press the **RESISTANCE ▲** key until you reach Resistance Level 20. Operate the EFX for another 2–3 minutes.
9. If the resistance of the EFX does not change or the EFX operation feels inconsistent with Resistance Levels 1 and 10, troubleshoot per Procedure 6.4.
10. Check the LED’s mounted on the upper PCA and the function keys displayed on the electronic console by performing Procedure 2.1.
11. Turn off the EFX with the on/off switch, then unplug the power cord from the wall outlet.

Procedure 5.1 - Measuring the Resistance of an Eddy Current Magnet

Caution

Remove power from the EFX before you measure magnet resistance.

Procedure

1. Set the on/off switch in the "off" position, then unplug the power cord from the wall outlet.

WARNING

Before continuing with this procedure, review the Warning and Caution statements listed in Section One, Things You Should Know.

1. Remove the rear covers as described in Procedure 7.1.
2. Set the ohmmeter to a range that will conveniently read up to 125Ω .
3. Disconnect the J1 (magnet) connector from the lower PCA. Measure the resistance between the two terminals of the connector removed from the lower PCA. See Diagram 6.5.

Diagram 5.1 - Eddy Current Magnet

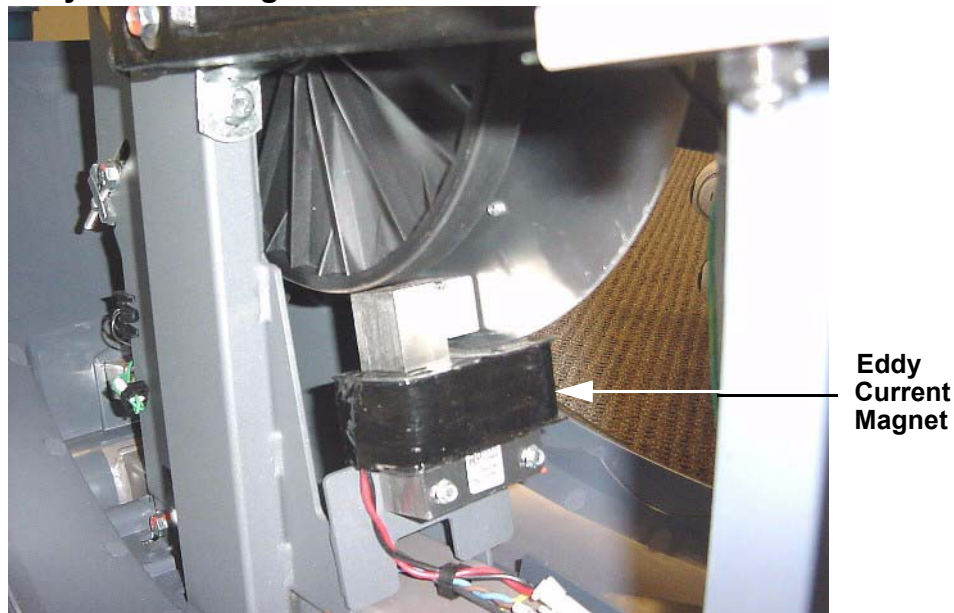

Note:

The resistance of the magnets will be higher than optimum ($90 - 110\ \Omega$) when they are warm.

4. If the resistance measures significantly low or open, replace the magnet per Procedure 7.13.
5. Re-install the rear covers as described in Procedure 7.1.
6. Set the on/off switch in the "on" position. Thoroughly test all functions per Section Four.

Procedure 5.2 - Inspecting and Adjusting Belt Alignment and Tension

Procedure

1. Set the on/off switch in the "off" position, remove the A.C. line cord from the A.C. outlet.

WARNING

Before continuing with this procedure, review the Warning and Caution statements listed in Section One, Things You Should Know.

2. Remove the rear covers as described in Procedure 7.1.
3. Remove both stairarms as described in Procedure 7.17.
4. Operate the unit by rapidly rotating a crankarm by hand. As the unit operates watch the drive belts for proper alignment. The belts should operate parallel to each other and the belts should maintain even spacing.
5. If the belts are not correctly aligned...

THEN...

Continue with the next step.

OTHERWISE...

Skip to step 13

6. Refer to Diagram 5.3 for the following belt alignment steps. The right and left step up belt tension bolts have locking tabs. If necessary, use pliers to bend the locking tabs out of the way so that the bolts can be turned.
7. If the step up pulley belt is out of alignment to the right, continue with step 9.
8. If the step up pulley belt is out of alignment to the left, continue with step 11.
9. Turn the left step up belt tension bolt 1/4 turn clockwise, then repeat step 4. If turning the left adjustment bolt 1/4 of a turn was not sufficient, turn the right step up belt tension bolt 1/4 of a turn counterclockwise.
10. Repeat step 9, alternating between the left and right step up belt tension bolts until the alignment is correct. Continue with step 13.
11. Turn the right step up belt tension bolt 1/4 of a turn clockwise, then repeat step 4. If turning the right step up belt tension bolt 1/4 of a turn was not sufficient, turn the left step up belt tension bolt 1/4 turn counterclockwise.
12. Repeat step 11, alternating between the right and left step up belt tension bolts until the alignment is correct.

13. Belt tension must now be checked and if necessary corrected. Remember, if it is necessary to change belt tension, the belt alignment must be maintained.

Diagram 5.3 - Drive Unit

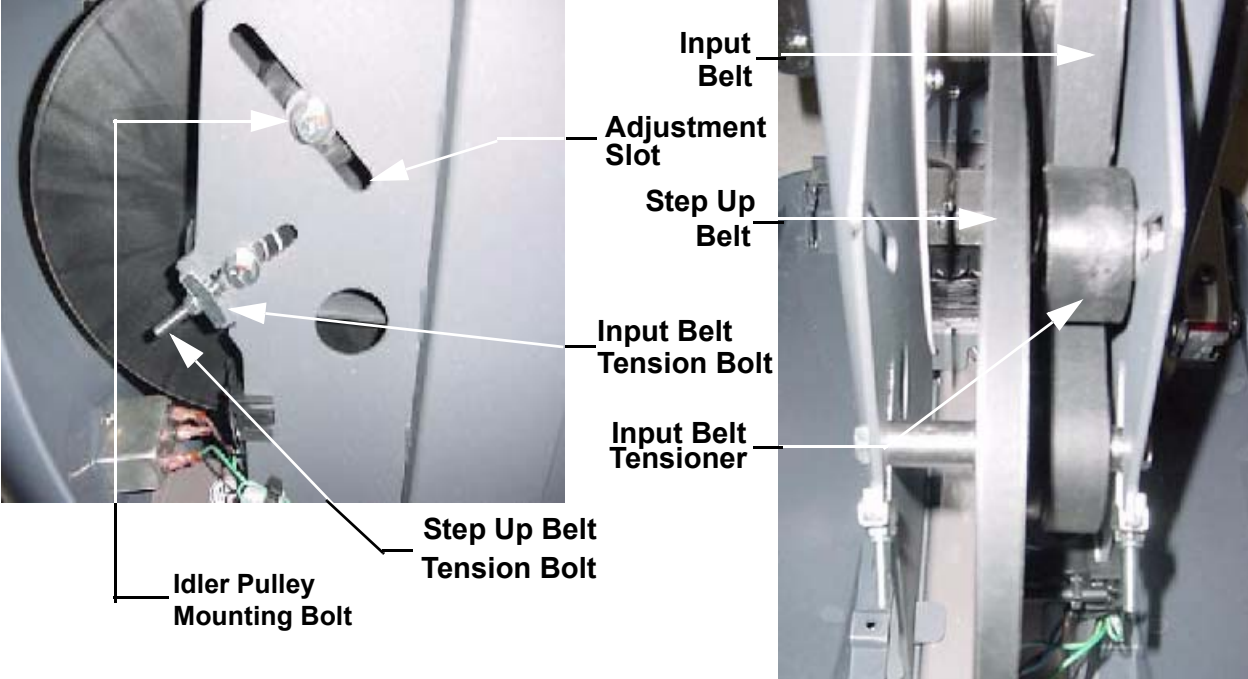

14. Place a belt gauge (McMaster-Carr 6160K12 or Grainger 3HX33) in the middle of the step up belt at the center of the belt span (see Diagram 5.4). Lay a straight edge along the length of the belt and beside the belt gauge. Slide one of the o-rings up against the shoulder of the belt gauge. Press downward on the belt gauge, causing the belt to deflect. Read the deflection on the belt gauge at the edge of the straight edge. Deflect the belt 1/4". Read the tension across the top edge of the o-ring. If the belt is correctly tensioned the gauge will read between 14 and 16 pounds.

15. If the tension in step 14 is correct skip to step 18. Otherwise continue with the next step.

Diagram 5.4 - Measuring Belt Tension

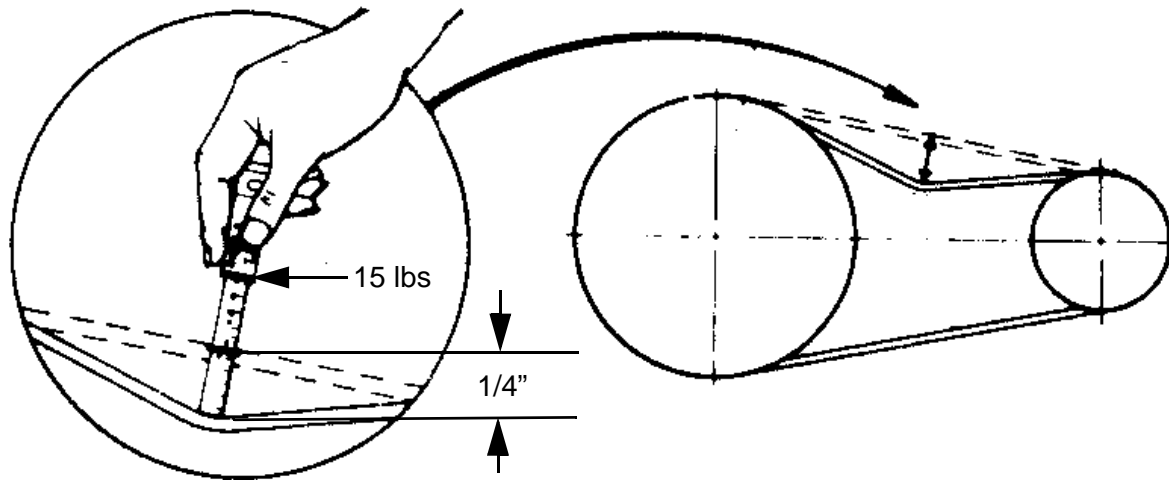

16. If the locking tabs on the right and left step up belt tension bolts have not been straightened, use pliers to bend the locking tabs out of the way so that the bolts can be turned.

IF...

The belt tensioning gauge reads less than 14 pounds

THEN...

Turn both tension bolts **clockwise**, in equal quarter-turn increments, until the belt tensioning gauge reads 14 - 16 pounds @ 1/4" deflection.

The belt tensioning gauge reads more than 16 pounds

Turn both tension bolts **counterclockwise**, in equal quarter-turn increments, until the belt tensioning gauge reads 14 - 16 pounds @ 1/4" deflection.

17. Verify that the belt alignment is still correct by performing the procedure in step 4.
18. When both the step pulley belt tension and alignment are correct, use pliers to bend the tension bolt locking tabs into the "locking" position.
19. The input pulley tension must now be checked and corrected, if necessary. There is not sufficient room to use the belt tension gauge to set the input pulley belt tension. It will be necessary to use the correctly tensioned step up belt as a comparison to set the input belt tension.
20. Using your finger, press in on the center of the step up pulley belt to get a feeling of how much pressure it takes to deflect the belt a 1/4".
21. Using your finger, press in on the center of the lower span of the input belt. Compare the pressure required to deflect the input belt to the pressure required to deflect the step up belt.

22. Slide a stout screwdriver blade into the adjustment slot, See Diagram 5.3, to the upper left of the idler pulley. Using the screwdriver as a lever, press the pulley down and to the right. While maintaining constant pressure on pulley, check the belt tension with your finger. When the belt tension feels correct, tighten and torque the input belt tension bolt to 200 inch pounds (17 foot pounds).
23. Replace the stairarms per Procedure 7.17.
24. Check drive input adjustment per Procedure 5.4.
25. Check the operation of the unit as described in Section Four, then re-install the rear cover as described in Procedure 7.1

Procedure 5.3 - Calibrating the Lift Motor

1. In order to calibrate the lift motor, it is necessary to disconnect the lift motor from the ramp assembly.
2. Set the on/off switch in the “off” position. Remove the front cover per Procedure 7.21.
3. Remove the two bolts that retain the lift yoke to the ramp assembly. Support the lift motor and ramp assembly as you separate the lift yoke from the ramp assembly. Lower the ramp assembly until it is resting on the rear lift cover.

Diagram 5.5 - Lift Motor Calibration

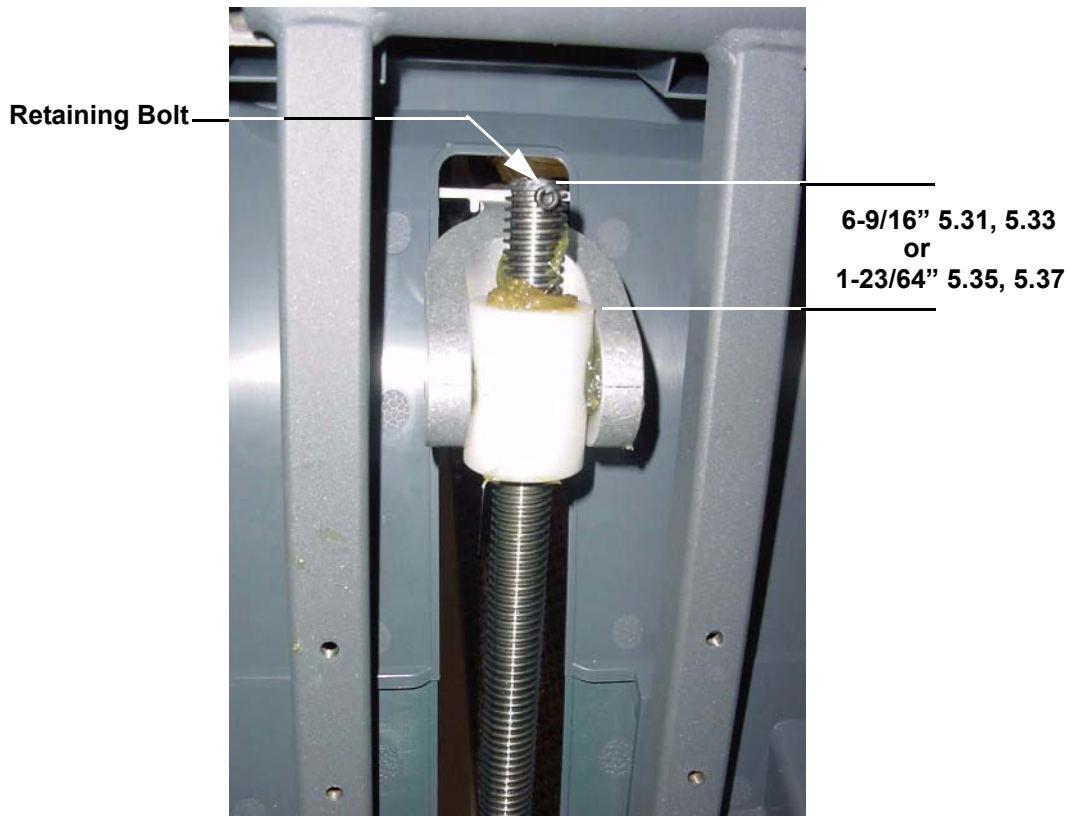

4. Set the on/off switch in the “on” position. Enter the diagnostics routine per Procedure 2.1. Proceed through the diagnostic routine until the lift A/D number is displayed.
5. Operate the **CROSSRAMP ▲** or **CROSSRAMP ▼** keys as required to set the lift A/D number to 163 (5.31, 5.33) or 223 (5.35, 5.37).
6. Rotate the lift yoke on the lift motor drive screw until the distance from the upper surface of the plastic nut in the lift yoke to the end of the drive screw is 6-9/16" (5.31, 5.33) or 1-23/64" (5.35, 5.37). If the lift motor drive screw rotates the lift calibration number will no longer be 163 (5.31, 5.33) or 223 (5.35, 5.37). The lift calibration number must be 163 (5.31, 5.33) or 223 (5.35, 5.37) and the distance measurement must be correct for the lift calibration to be correct. See Diagram 5.5.

7. Set the on/off switch in the "off" position. Do not exit the diagnostic program in the normal manner. Exiting the diagnostic program may cause the lift to self center and invalidate the lift calibration just performed.
8. Raise the ramp assembly to a convenient height and slide the lift yoke into the ramp assembly. Hand tighten the lift yoke mounting bolts and then torque them to 240 inch pounds (20 foot pounds).
9. Set the on/off switch in the "on" position. Thoroughly test all lift functions.
10. Set the on/off switch in the "off" position, replace the front cover per Procedure 7.21.

Procedure 5.4 - Drive Input Assembly Adjustments

This procedure ensures that the drive input assembly, the drive belts and the eddy current magnet are correctly adjusted and aligned. All of the checks described in this procedure must be performed to ensure proper operation.

1. Set the on/off switch in the “off” position, remove the A.C. line cord from the A.C. outlet.

WARNING

Before continuing with this procedure, review the Warning and Caution statements listed in Section One, Things You Should Know.

2. Remove the rear covers as described in Procedure 7.1.
3. Remove both stairarms as described in Procedure 7.17.

Input Drive Assembly Axle Alignment

4. Rotate one of the crankarms to the twelve o'clock position and measure the distance from the crankarm to the frame weldment. See Diagram 5.6. Rotate the opposite crankarm to the twelve o'clock position and measure the distance from the crankarm to the frame weldment. If the two measurements are different by more than 1/16 inch, continue with step 5. If the two measurements are within 1/16 inch, skip to the “input drive axle to step up pulley axle alignment” procedure.

Diagram 5.6 - Crankarm to Frame Weldment Measurements

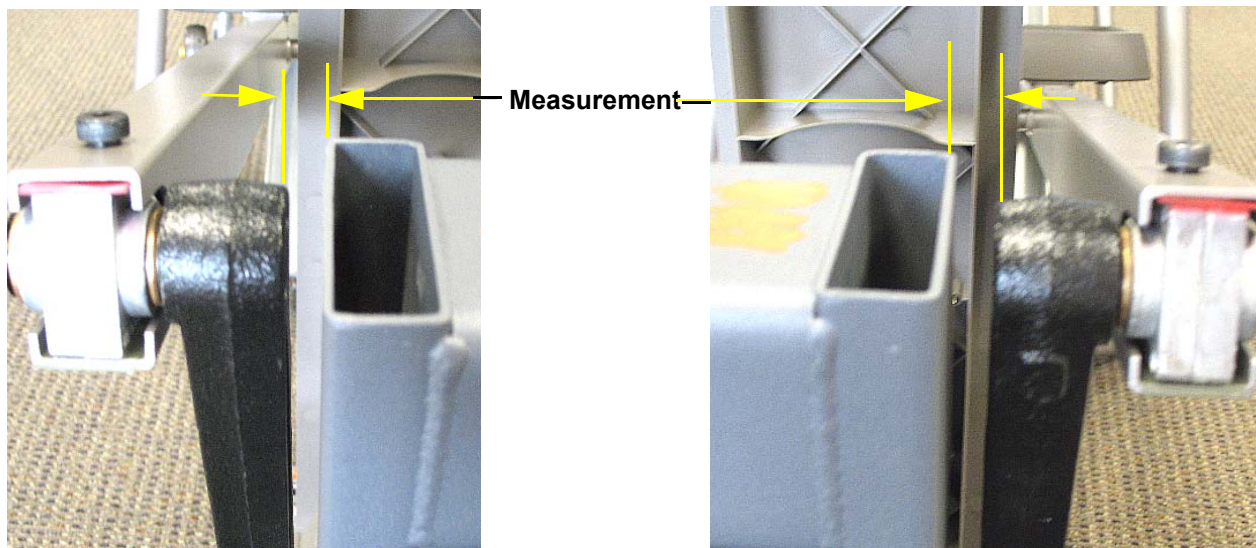

5. On the side with the larger measurement, loosen the upper pillow block mounting bolt only, do not loosen the lower pillow block mounting bolt. On the side with the smaller measurement, loosen both pillow block mounting bolts. See Diagram 5.7. For purposes of illustration we will assume that the left measurement was larger than the right side measurement in Diagram 5.6.

Diagram 5.7 - Pillow block Mounting Bolts

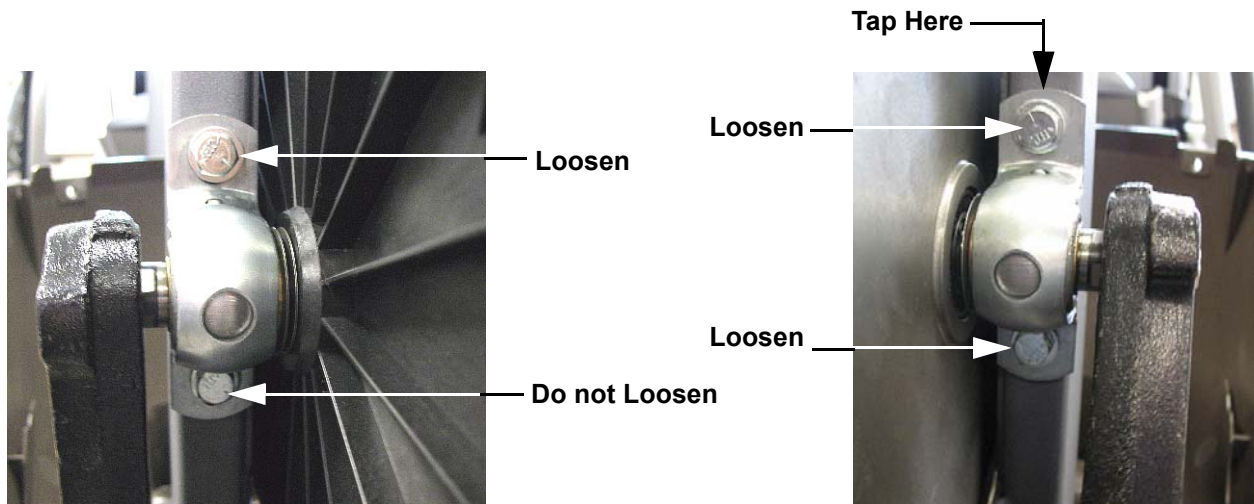

6. Using a rubber mallet, gently tap the top of the pillow block with two loosened bolts (the right hand pillow block in Diagram 5.7) until the two measurements in Diagram 5.6 are within 1/16 inch.
7. Torque the three loosened pillow block mounting bolts to 120 inch pounds (10 foot pounds).

Input Drive Axle to Step Up Pulley Axle Alignment

8. Mark the current position of the step up pulley on both side of the drive weldment.
9. On both sides of the drive weldment measure the distance from the input drive axle to the step up pulley axle. See Diagram 5.8.

Diagram 5.8 - Axle to Axle Measurement

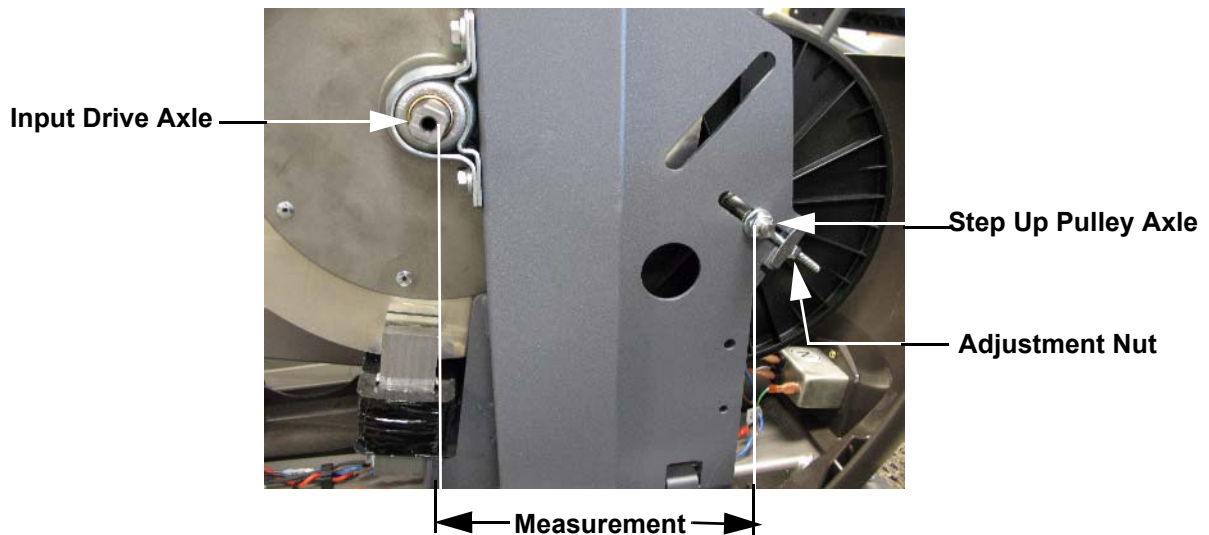

10. If the difference between the two measurements is greater than 1/16 inch, continue with step 11. If the difference is less than 1/16 inch, skip to “eddy current magnet adjustment”.
11. You will be adjusting one half of the difference between the two measurements with each of the step up pulley adjustment nuts.
12. On the side with the smaller measurement, turn the adjustment nut slowly clockwise so that it moves 1/2 of the difference between the two measurements.
13. On the side with the larger measurement, turn the adjustment nut slowly counter-clockwise so that it moves the remaining 1/2 of the difference between the two measurements.
14. Return to step 9 and repeat any necessary steps.

Eddy Current Magnet Adjustment

15. Check the position of the eddy current magnet relative to the eddy current disk. The eddy current disk should be centered in the slot in the eddy current magnet. See Diagram 5.9.

Diagram 5.9 - Eddy Current Magnet

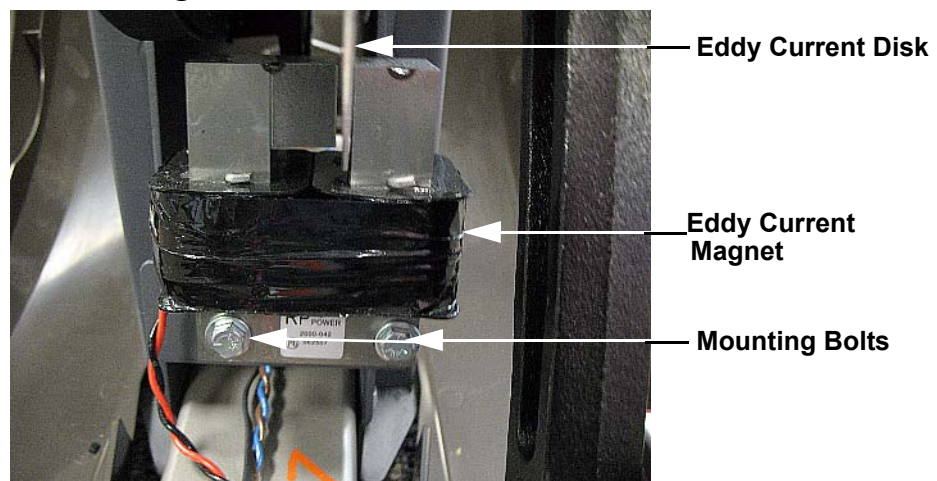

16. If the eddy current disk is not centered, loosen the two eddy current magnet mounting bolts and move the magnet to center the eddy current disk.
17. Tighten and torque the eddy current magnet mounting bolts to 66 inch pounds.

Drive Belt Tracking

18. Stand behind the EFX and sight down the step up pulley drive belt (the narrower belt) to ensure that the belt is tracking in the center of the step up pulley. If the belt has run off of one side of the pulley, apply pressure to that side of the belt and slowly rotate the step up pulley to “walk” the belt back onto the step up pulley.
19. Repeat the procedure in step 18 with the primary drive belt (wider belt).
20. Replace both stairarms as described in Procedure 7.17.
21. Replace the rear covers as described in Procedure 7.1.

Procedure 6.1 - Troubleshooting the Lower and Upper Data Cable

Typical symptoms associated with a defective data cable is either an error 30 or no power to the upper PCA. This procedure requires that you have a known good upper data cable, lower data cable and mid-point connector.

1. If you are troubleshooting an error 30, 31 or 32 continue with step 2, otherwise see Procedure 6.5.
2. Expose the upper top of outrigger tubes by removing the upper and lower display bracket covers from the rear of the display.
3. Remove the three bolts that fasten the top, remove the four bolts that fasten the bottom and remove the clamp from the center of the left outrigger tube. See Diagram 6.1.

Diagram 6.1 - Left Outrigger Tube

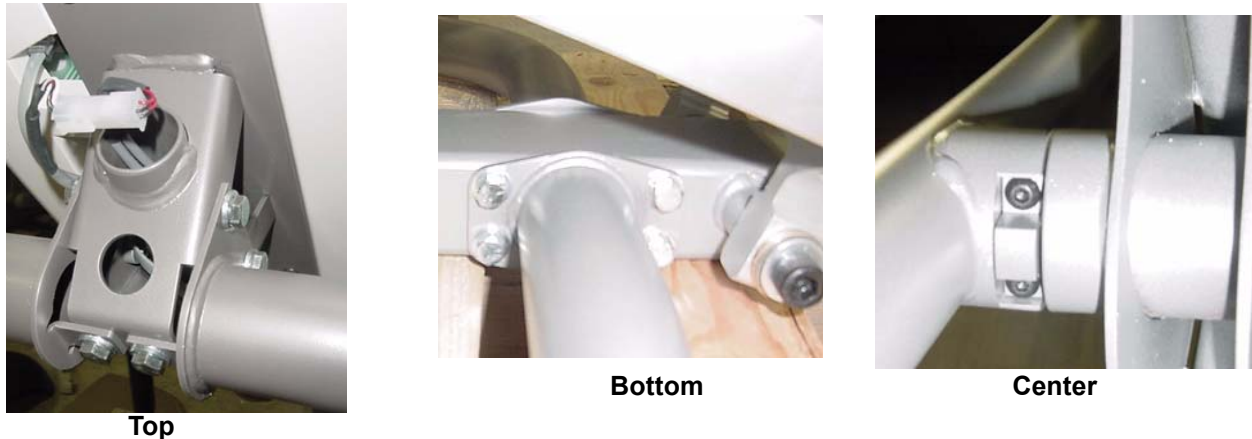

4. There is a data cable in the left outrigger tube, care must be taken when removing the outrigger tube to avoid damaging the data cable. Carefully remove the left outrigger tube from the shaft at its center point.
5. Slide the upper data cable, the cable in the outrigger tube, out of the main frame tube to expose the mid-point connector and the lower data cable.
6. Disconnect both cables from the mid-point connector and replace the mid-point connector with a known good mid-point connector. If the mid-point connector does not correct the problem, replace the original mid-point connector and continue with step 7.
7. Remove the top, left and right rear covers per procedure 7.1.
8. Remove the cover from the lower PCA.
9. Disconnect the lower data cable from the lower PCA and the mid-point connector. Substitute a known good data cable from the lower PCA to the mid-point connector. It is not necessary to route the test data cable through the frame tube, for convenience route it externally.

10. If the lower data cable corrects the problem, replace the cable. If the lower data cable does not correct the problem, re-connect the original lower data cable to the lower PCA and mid-point connector and continue with step 11.
11. Remove the cover from the rear of the display. Disconnect the upper data cable from the mid-point connector and the upper PCA. See Diagram 6.2. Substitute a known good data cable from the upper PCA to the mid-point connector. It is not necessary to route the test data cable through the frame tube, for convenience route it externally.

Diagram 6.2 - Upper Display Cable

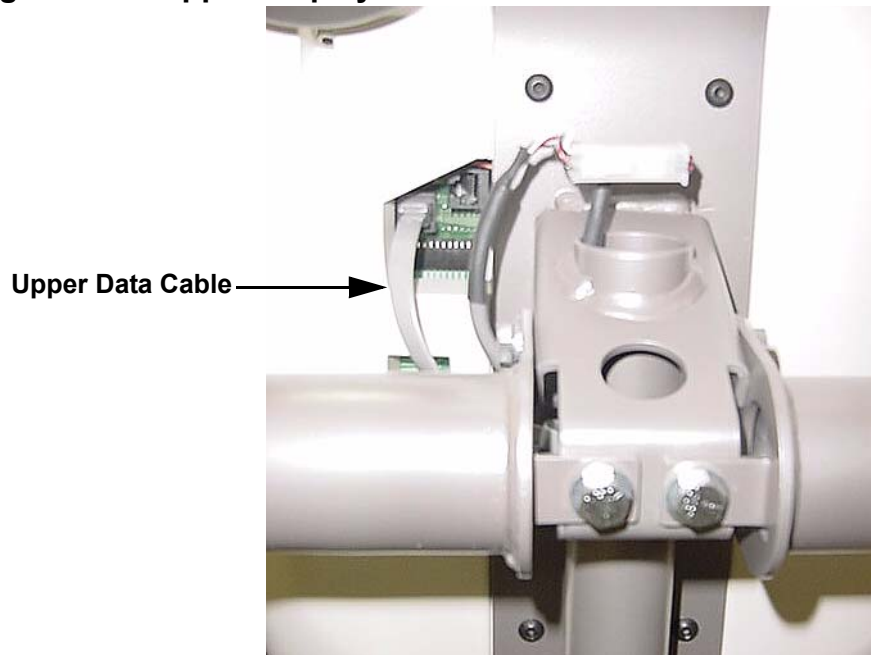

12. If the upper data cable corrects the problem, replace the cable. If the upper data cable does not correct the problem, re-connect the original upper data cable to the mid-point connector and the upper PCA and continue with step 12.
13. If you have performed all of the procedures above and have been unable to correct the problem, call Precor customer service.

Procedure 6.2 - Troubleshooting the Keypad and Upper PCA

If the function keys on the electronic console are unresponsive, the problem may be either the upper PCA or keypad.

Procedure

1. Set the on/off switch in the "off" position.

WARNING

Before continuing with this procedure, review the Warning and Caution statements listed in Section One.

2. If the EFX powers up and functions normally until a particular key(s) is pressed, skip to step 10. If a **"STUCK KEY"** message is immediately displayed when the EFX is powered up, continue with the next step.
3. This condition may be caused by either one of the keypads or upper PCA. Set the on/off switch in the "off" position. Remove the display bracket cover from the rear of the display. Disconnect heart rate cables. Disconnect the data cable from the Upper PCA. See Diagram 6.2.
4. Remove the three screws that fasten the accessory tray to the upper portion of the display. Remove the four screws that fasten the display housing front panel to the display housing back panel.
5. Lift the display housing front panel off of the display housing backing plate. Remove the keypad cable and the D Pad cable from the upper PCA. See Diagram 6.3.

Diagram 6.3 - Upper PCA & Keypad

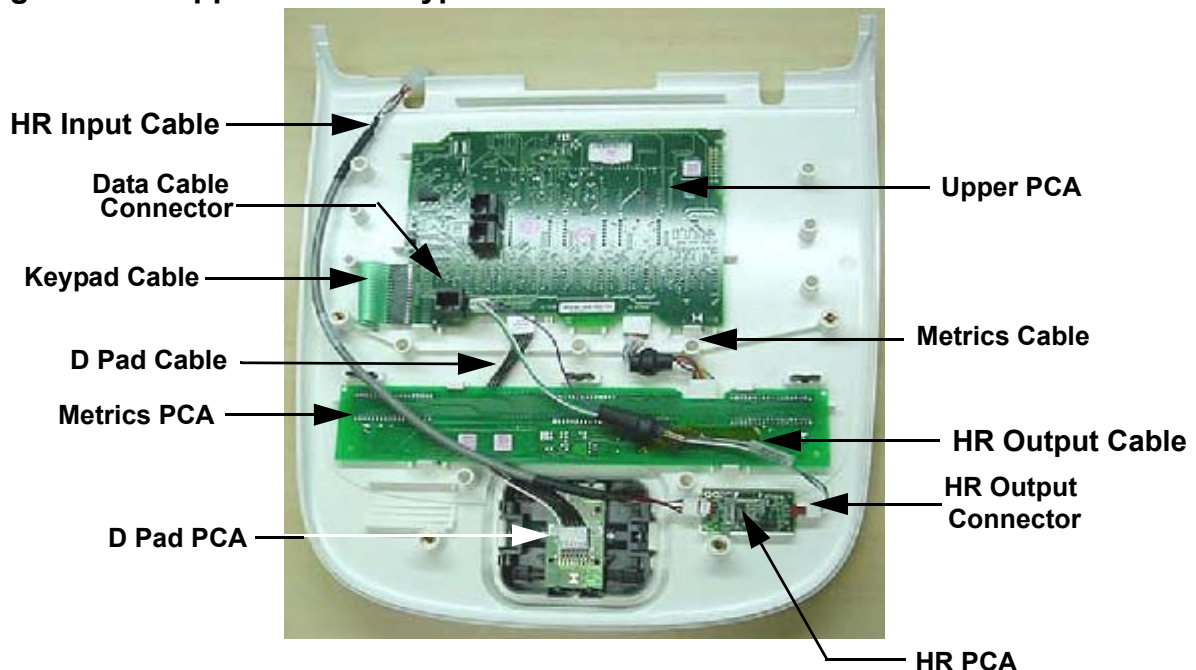

6. Set the display back in its mounting position and reconnect the data cable. Set the on/off switch in the “on” position.
7. If a “**STUCK KEY**” message is immediately displayed when the EFX is powered up, replace the upper PCA.
8. If a “**STUCK KEY**” message is not displayed when the EFX is powered up, either the main keypad or the D-pad is the problem.
9. Set the on/off switch in the “off” position. Reconnect the D-pad cable. Set the on/off switch in the “on” position. If a “**STUCK KEY**” message is displayed, replace the D-pad.
10. If a “**STUCK KEY**” message is not displayed, replace the display housing front panel. The display housing front panel is equipped with the main keypad.
11. If you have performed all of the procedures above and have been unable to correct the problem, call Precor customer service.
12. Access the diagnostics program per procedure 2.1.
13. Test the keypad per Procedure 2.1, step 7.
14. If all of the keys test good, the problem may be user error or a key function that is normally disabled during a particular user program.
15. If one or more keys do not function correctly, either the keypad (display housing) or upper PCA could be defective. Replace the display and repeat step 11. If the display housing did not correct the problem, re-install the original display housing and replace the upper PCA.
16. If you have performed all of the procedures above and have been unable to correct the problem, call Precor customer service.

Procedure 6.3 - Troubleshooting the Speed Sensor

Circuit Description

The speed sensor is a reed switch. A magnet is mounted on the step up pulley. The magnet passes the speed sensor once per revolution. The output from the speed sensor is a 5 Vdc square wave, the frequency of which indicates the operating speed. When a square wave output is not being generated from the speed sensor the system assumes the unit is not in use.

WARNING

Before continuing with this procedure, review the Warning and Caution statements listed in Section One, Things You Should Know.

Procedure

1. Remove the upper and right rear cover sections per Procedure 7.1. Set the on/off switch in the “on” position. Operate the unit. If the system timer has not started and a stride rate is not displayed, the speed sensor is not operative. We shall use the presence of a stride rate to determine when the speed sensor is functioning normally.
2. A magnet must be installed in the step up pulley. If the stride rate is not being displayed in step 1, verify that a magnet is installed in the step up pulley. See Diagram 6.4.

Diagram 6.4 - Speed Sensor

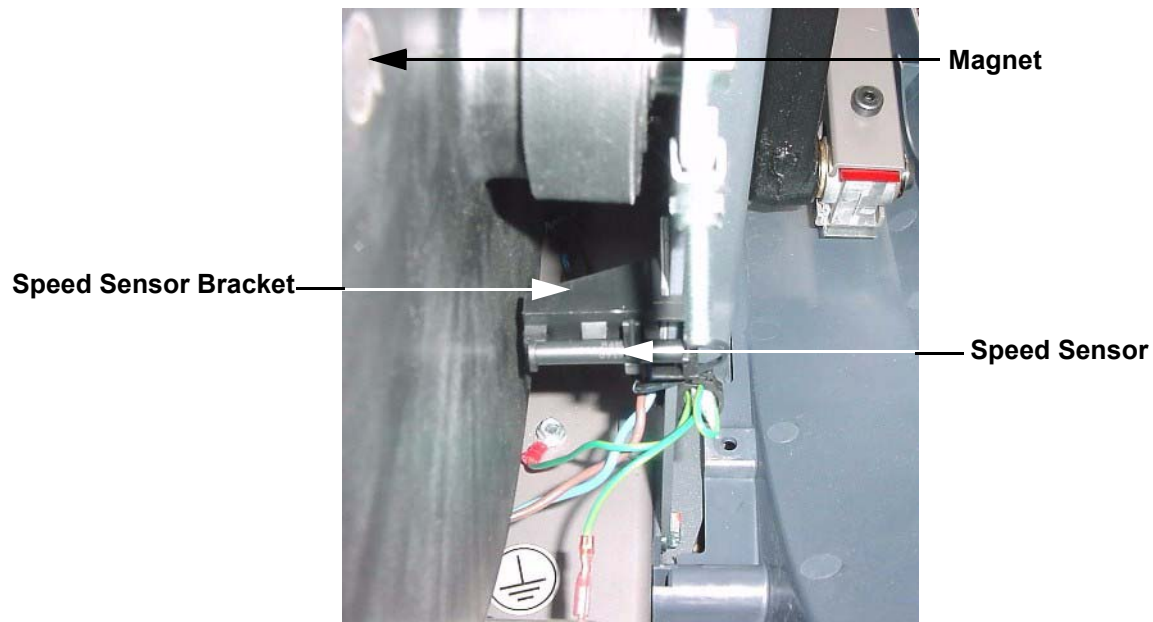

3. Rotate the step up pulley so that the speed sensor magnet is not near the speed sensor. Using a DC voltmeter, measure the voltage between terminal 1 and terminal 2 of J8 on the lower PCA. The measurement should be approximately 5 Vdc. See Diagram 6.5. If the measurement is correct, skip to step 4. If the voltage is missing or significantly low, disconnect the speed sensor and repeat the voltage measurement on the J8 on the lower PCA. If the measurement is now correct (5 Vdc), replace the speed sensor. If the voltage is still missing or significantly low, replace the lower PCA. Skip to step 8.
4. Rotate the step up pulley so that the speed sensor magnet is next to the reed switch. Using a DC voltmeter, measure the voltage between terminal 1 and terminal 2 of J8 on the lower PCA. The measurement should be approximately 0 Vdc. If the voltage is 5 Vdc or significantly high, replace the speed sensor per Procedure 7.12. Skip to step 8.
5. With the an ohmmeter connected to terminals 1 and 2 of J8 on the lower PCA, rock the step up disk forward and backward so that the magnet is passing in front of and away from the reed switch. The ohmmeter should alternate between continuity (very low resistance) and infinity (open circuit). If the resistance measurement does not alternate between continuity and infinity, repeat steps 2 through 4. If the resistance does alternate between continuity and infinity, continue with step 6.
6. If you have performed all of the above tests and the stride rate is not displayed when the unit is operated, there are three parts that could cause the problem. There are not any good tests to check these parts other than substituting a known good part. They are lower PCA, data cable and upper PCA. Replace only one part at a time. If the new part does not correct the problem, replace the original part.
7. If you have performed all of the above tests and the speed sensor is still not functioning, call Precor Technical Support.
8. Check the operation of the EFX as described in Section Four.

Procedure 6.4 - Troubleshooting the Eddy Current System

Note:

If the control circuit does not see an output from the speed sensor, it removes power from the eddy current system. Therefore, when it is necessary to check the resistance or take voltage measurements in the eddy current system it will be necessary to slowly turn the flywheels to ensure that the power time out has not occurred.

WARNING

Before continuing with this procedure, review the Warning and Caution statements listed in Section One, Things You Should Know

1. Remove the upper, right and left rear covers per Procedure 7.1. There are four typical symptoms concerning the eddy current system. No resistance (pedaling resistance), no resistance shortly after power up, incorrect resistance and error 50. If the problem is no resistance, continue with step 2. If the problem is no resistance shortly after power up, test the speed sensor per Procedure 6.3. If the problem is incorrect resistance, skip to step 6. If the problem is an error 50, skip to step 10.
2. Set the on/off switch in the “on” position, enter the manual program and set the resistance at level 10. Using a DC voltmeter, check the voltage across the magnet wires at the lower PCA (J1-1 & J1-2). The voltage should measure approximately 25 Vdc. If the voltage is missing or significantly low, continue with step 4
3. Set the on/off switch in the “off” position. Using an ohmmeter, measure between the magnet wires at the lower PCA. The measurement should be approximately 90 Ω to 110 Ω . If the measurement is open (∞), check the connections at both magnets and the lower PCA and the wires between the lower PCA and the magnets. The lower PCA to magnet wires must read less than 1 Ω when measured from end to end with an ohmmeter. Check the EFX per Section Four.
4. If all of the wiring connections are good and there is still no resistance, there are two parts that could cause the problem. There are not any good tests to check these parts other than substituting a known good part. They are the lower PCA and the upper PCA. Replace only one part at a time. If the new part does not correct the problem re-install the original part.
5. If you have performed all of the above tests and there is still no resistance, call Precor Technical Support.
6. If the resistance is greater than normal, the cause could be mechanical rather than electrical. Set the on/off switch in the off position and test the unit by checking all moving parts in the drive section and stairarms for worn parts that could be “binding”. Replace the appropriate parts.

7. Set the on/off switch in the “on” position, enter the manual program and set the resistance at level 10. Using a DC voltmeter, check the voltage across the magnet wires at the lower PCA. The voltage should measure approximately 25 Vdc.
8. If the voltage is still significantly high or low, there are two parts that could cause the problem. There are not any good tests to check these parts other than substituting a known good part. They are lower PCA and upper PCA. Replace only one part at a time. If the new part does not correct the problem, re-install the original part.
9. Set the on/off switch in the “off” position. Using an ohmmeter, measure between the magnet wires at the lower PCA. The measurement should be approximately 90Ω to 110Ω. If the measurement is significantly low, check the connections at both magnets and the lower PCA.
10. With an ohmmeter, measure between each magnet wire and frame ground. A normal reading for both measurements is open (∞). If the resistance is significantly low, disconnect the J2 connector from the lower PCA and the eddy current magnet.
11. If you have performed all of the above tests and the resistances are still incorrect, call Precor Technical Support.

Procedure 6.5 - Upper Display does not illuminate

Note:

If the control circuit does not see an output from the speed sensor, it removes power from the eddy current system. Therefore, when it is necessary to check the resistance or take voltage measurements in the eddy current system it will be necessary to slowly turn the flywheels to ensure that the power time out has not occurred.

WARNING

1. Before continuing with this procedure, review the Warning and Caution statements listed in Section One, Things You Should Know
1. Set the on/off switch in the "off" position, unplug the line cord from the wall outlet.)
2. Remove the fuses from the power entry module. (See Procedure 7.24)
3. Check all of the fuses with an ohmmeter. They should read less than 1Ω . Replace any fuse that reads significantly high. See Procedure 7.24.
4. With the line cord still unplugged from the wall outlet, set the on/off switch in the "on" position. Check between the power terminals of the line cord with an ohmmeter. The ohmmeter should read 1 to 1.5 megohm.
5. If the reading is good, skip to step 10, if the reading is significantly low, continue with the next step
6. If the reading in step 4 is significantly low, check the wiring between the lower PCA and the on/off switch, between the on/off switch and the input module. Replace any cut or nicked wiring.
7. Check the line cord for nicked or cut wiring. Replace the line cord if necessary.
8. If the reading in step 4 is still significantly low, replace the lower PCA
9. If you have performed all of the above tests and are unable to resolve the problem, contact Precor customer support.
10. Plug the line cord into the wall outlet and set the on/off switch in the "on" position.
11. Measure between terminals 2 & 3 (white and violet wires) of the HR output connector on the HR PCA with a DC voltmeter. See Diagram 6.3. The reading should be approximately 5.0 Vdc.
12. If the reading in step 11 is good, replace the upper PCA. If the reading in step 12 is significantly low, set the on/off switch in the "off" position. Disconnect the data cable from the upper PCA.
13. Set the on/off switch in the "on" position.

14. Measure between TP20 and TP2 on the lower PCA with a DC voltmeter. See Diagram 6.5. The reading should be approximately 7.5 Vdc. If the measurement is good, replace the upper PCA. If the measurement is significantly low, continue with step 15.
15. Disconnect the speed sensor cable from the lower PCA and repeat the measurement in step 15. If the measurement is good, replace the speed sensor. If the measurement is significantly low, replace the data cable.
16. If you have performed all of the above tests and are unable to resolve the problem, contact Precor customer support.

Diagram 6.5 - Lower PCA

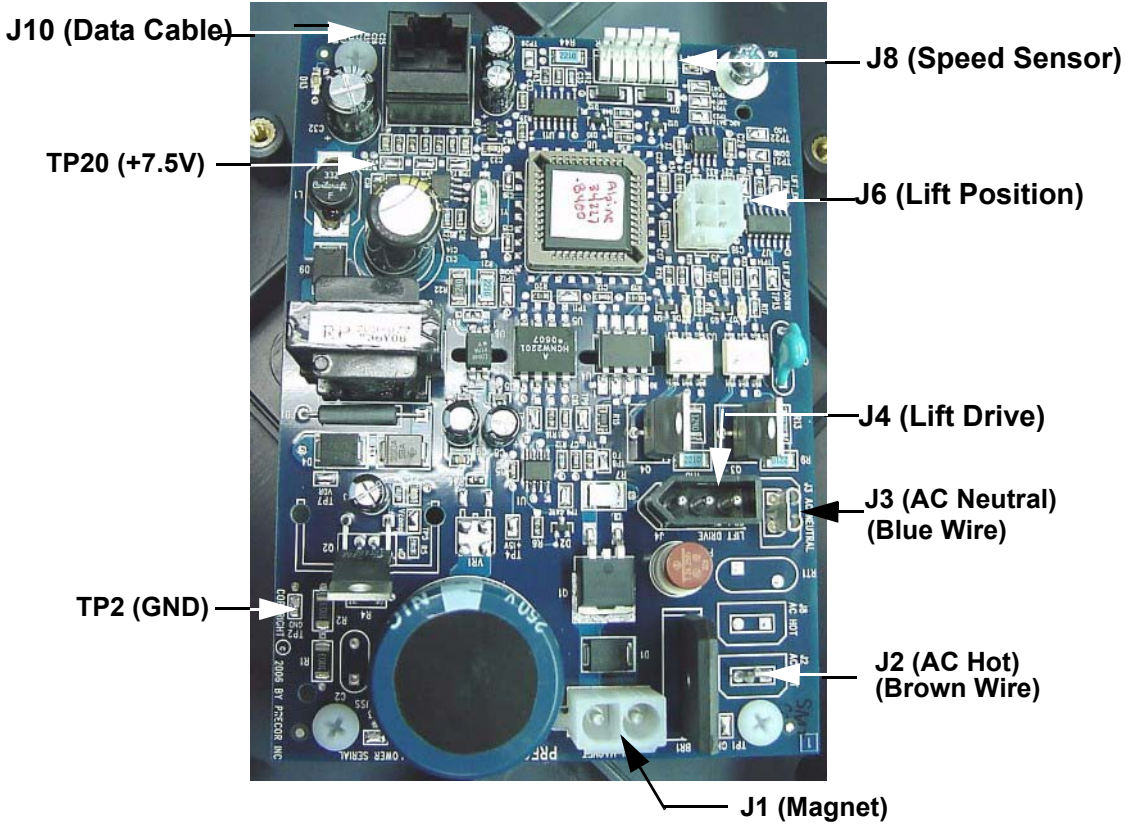

Procedure 6.6 - Troubleshooting the Lift System

Note:

The lift motor is disabled when the EFX is not being used. The speed sensor must detect motion in order for lift operation to be enabled. In the following procedures, when lift motor movement is being tested the stairarms must be in motion. Before performing this procedure, ensure that the speed sensor is operating normally per Procedure 6.3.

1. If the lift motor will not move skip to step 7. If the lift motor moves and an error occurs continue with step 2.
2. Access the diagnostics program per Procedure 2.1 and proceed to the lift calibration portion of the diagnostics program. If the lift calibration number is 0 or 255 skip to step 3. Operate the lift, if the lift calibration number does not increment as the lift moves, skip to step 3. If the calibration number increments as the lift moves, re-calibrate the lift per Procedure 5.3. If re-calibration does not correct the problem, continue with step 3.
3. Set the on/off switch in the "off" position. Remove the lift position cable connector from the lower PCA. Using an ohmmeter, measure between terminal 1 (brown wire) and terminal 3 (blue wire). The measurement should be approximately 1K Ω .
4. Using an ohmmeter, measure between terminals 1 and 2 of the lift position connector and measure between 2 and 3 of the lift position connector. The two measurements should total approximately 1K Ω . If any of the readings are open (∞) or significantly high, check the lift motor cable and connectors. Repair any wires or connections that are bad. If the cable and connectors are good, replace the lift motor.
5. If you have performed all of the above tests and an error still occurs when the lift motor operates, there are four parts that could cause the problem. There are not any good tests to check these parts other than substituting a known good part. They are the lower PCA, the upper data cable, the lower data cable and the upper PCA. Replace only one part at a time. If the new part does not correct the problem, replace the original part.
6. If you have performed all of the above tests and the lift system is still not functioning, call Precor Technical Support.
7. Set the on/off switch in the "off" position. Remove the F1 lift fuse (2 amp slow blow) fuse from the lower PCA. Measure the fuse with an ohmmeter. The measurement should be 1 Ω or less. If the fuse is good, re-insert the fuse and skip to step 9. If the fuse is open (∞) or significantly high, replace the fuse. Before operating the lift motor it is necessary to perform a continuity test on the lift motor.

8. Remove the lift power connector from the lower board. Using an ohmmeter, measure between terminals 1 and 2 (white and red) between terminals 1 and 3 (black and white) and between terminals 2 and 3 (red and black). The measurements should be approximately 14.7Ω , 14.3Ω and 29Ω , respectively. If any of the measurements are significantly low, replace the lift motor. If any of the readings are open (∞) or significantly high, check the lift motor cable and connectors. Repair any wires or connections that are bad. If the cable and connectors are good, continue with step 9.
9. Re-insert the lift power connector in the lower PCA. Set the on/off switch in the “on” position. Using an AC voltmeter, monitor the voltage between terminals 1 and 2 (white and red wires) of the lift power connector. Enter the manual program and press the **CROSSRAMP ▲** key. The measurement should be approximately 120 Vac (line voltage). If the voltage is present and the lift motor moves normally, skip to step 10. The voltage will only be present until such time as an error occurs. If line voltage is not present skip to step 11. If line voltage is measured but the motor does not move, replace the lift motor.
10. Monitor terminals 1 and 3 (white and black wires) of lift power connector. Enter the manual program and press the **CROSSRAMP ▼** key. The measurement should be approximately 120 Vac (line voltage). If the voltage is present and the lift motor moves normally skip to step 13. The voltage will only be present until such time as an error occurs. If line voltage is measured but the motor does not move, replace the lift motor.
11. If the upper display does not indicate that the lift is moving in both directions when the appropriate **CROSSRAMP** key is pressed the problem is either the upper PCA or the keyboard (display housing). Troubleshoot the keyboard per the keyboard portion of Procedure 2.1. If the keyboard is good, replace the upper PCA.
12. If the upper display indicates that the lift is moving in both directions when the appropriate **CROSSRAMP** key is pressed, the problem is either the upper data cable, lower data cable or the lower PCA. There are not any good tests to check these parts other than substituting a known good part. Replace only one part at a time. If the new part does not correct the problem, replace the original part
13. If you have performed all of the above tests and the lift system is still not functioning, call Precor Technical Support.

Procedure 7.1 - Replacing or Removing a Rear Cover Section

Warning: Care must be taken when work is being performed in the area of the stairarms. Pinch points exist between the stairarm and ramp and between the stairarm and crankarm, when the rear covers are removed.

Procedure

1. Set the on/off switch in the “off” position, then unplug the power cord from the A.C. outlet.

WARNING

Before continuing with this procedure, review the Warning and Caution statements listed in Section One, Things You Should Know.

2. This procedure details the removal and replacement of the entire rear cover assembly. It is only necessary to perform the portion of this procedure that is required to access the particular section or sections that you are replacing.
3. Reach inside one of the stairarm slots in the front portion of the rear cover and locate one of the release points shown in Diagram 7.1. Gently, press upwards on the release point to unsnap the access panel from the rear cover. Grasp the raised edge of the access panel and remove it from the rear cover assembly.

Diagram 7.1 - Rear Cover Access Panel

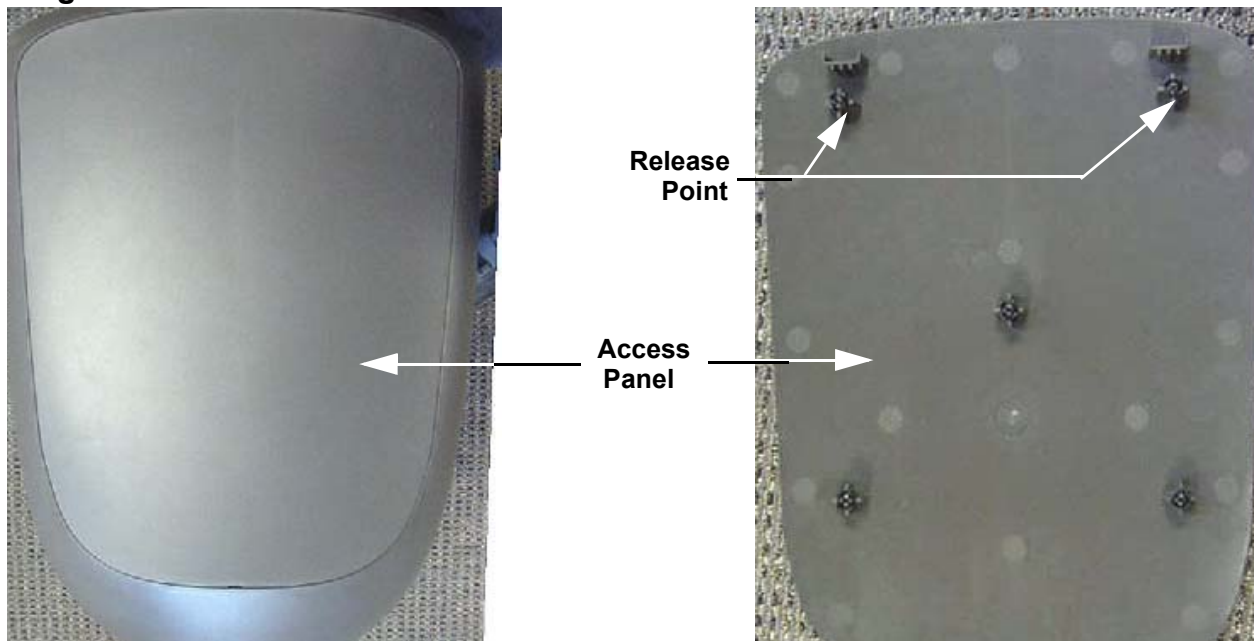

4. Remove the two screws in the rear of the cover assembly and the mounting screw shown in Diagram 7.2. Carefully pry the two snaps, shown in Diagram 7.2, toward the rear and remove the top cover.
5. Remove the left and right covers from the cover assembly.

Diagram 7.2 - Rear Cover assembly with the Access Panel Removed

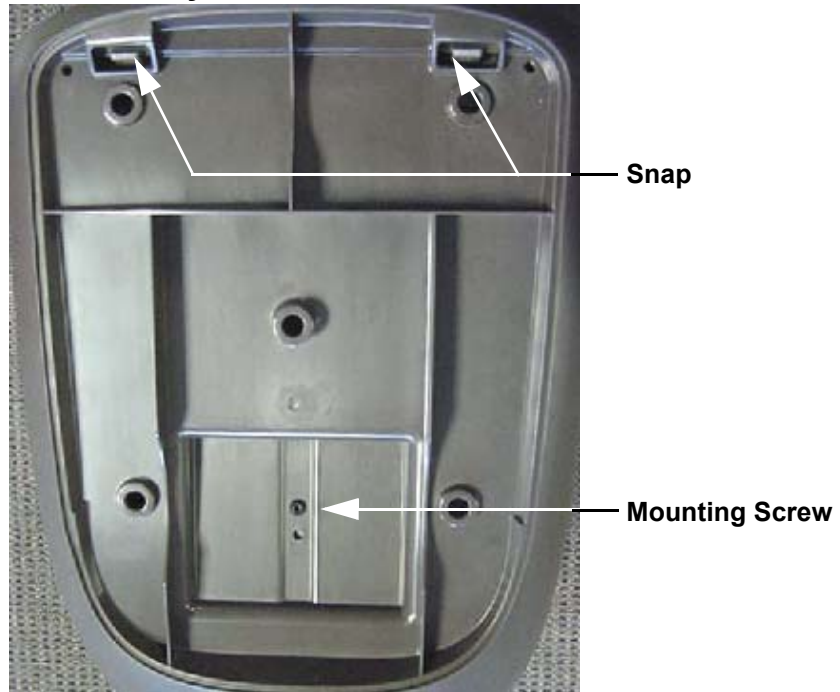

6. Remove the two screws that fasten the wedge cover to the frame and remove the wedge cover. See Diagram 7.3.

Diagram 7.3 - Wedged Cover



7. Remove the cover from the lower PCA. Remove the screws that fasten the lower PCA to the front cover section. Do not remove any of the wires or cables from the lower PCA. Remove the two screws that fasten the front cover section to the frame. See Diagram 7.4.

Diagram 7.4 - Bottom and Front Cover Sections

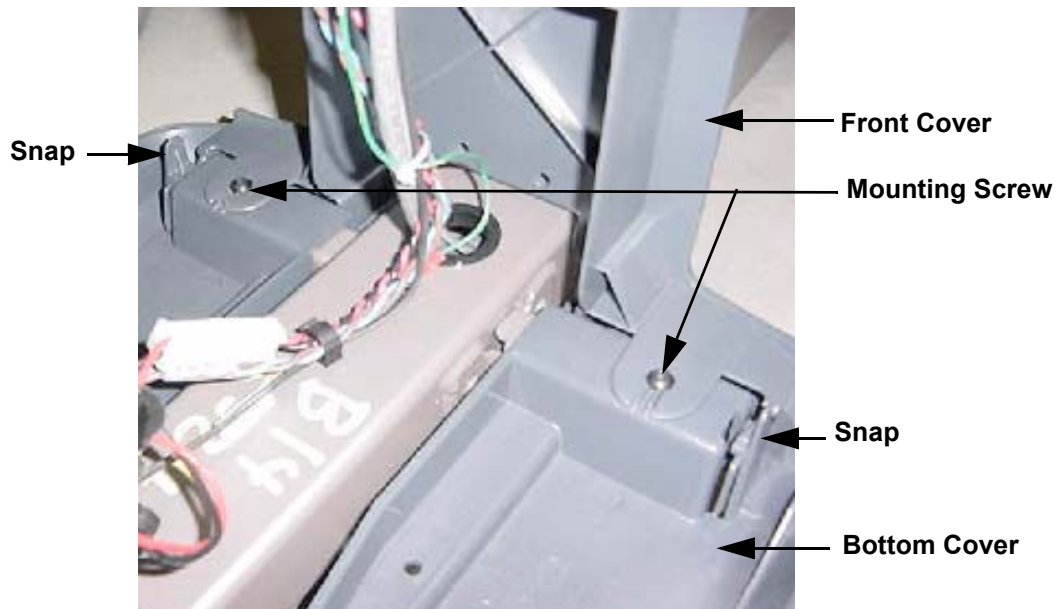

8. Remove the two screws that fasten the A.C. input module to the bottom cover section. Do not disconnect the wiring from the A.C. input module.
9. Remove the four screws that fasten the bottom cover section to the frame. Unsnap the front cover section from the bottom cover section and remove the front and bottom cover sections.
10. Set the bottom cover section in its mounting position and fasten it with the screws removed in step 9
11. Set the A.C. input module in its mounting position and fasten it with the hardware removed in step 8.
12. Snap the front cover in its mounting position on the bottom cover and fasten it with the screws removed in step 7, torque the screws to 6-9 inch pounds. Set the lower PCA in its mounting position and fasten it with the screws removed in step 7, torque the screws to 6-9 inch pounds. Re-install the cover on the lower PCA.
13. Set the wedge cover in its mounting position and fasten it with the screws removed in step 6., torque the screws to 6-9 inch pounds
14. Set the left and right cover sections in their mounting positions making sure that all of the tabs on the left and right cover are correctly aligned in the bottom cover section.
15. Set the top cover in its mounting position, and press it into the two snaps shown in Diagram 7.2. Fasten the top cover section with the three screws removed in step 4. Torque the screws to 6-9 inch pounds.
16. Place the access panel in its mounting position on the top cover and press it into place.

Procedure 7.2 - Replacing a Display Front Panel, Upper PCA, Heart Rate PCA or Metrics PCA

Procedure

The keyboard is part of the display housing front panel. If the keyboard is not functioning properly, replace the display housing front panel.

Removing the Display Housing Front Panel

1. Set the on/off switch in the “off” position, then unplug the power cord from the A.C. outlet.

WARNING

Before continuing with this procedure, review the Warning and Caution statements listed in Section One, Things You Should Know.

2. Attach an anti-static wrist strap to your arm, then connect the ground lead of the wrist strap to the units frame.
3. Remove the display bracket cover from the rear of the display.
4. Disconnect the data cable, with ferrite core, from the rear of the upper PCA. Disconnect the heart rate cables, if applicable. See Diagram 6.2.
5. Remove the three screws that fasten the accessory tray to the top of the display, remove the accessory tray.
6. Remove the four screws that secure the display housing front panel to the display backing plate.

Removing and Replacing the Upper PCA

7. Disconnect the heart rate cable (J16), the metrics PCA cable (J13), the keypad cable (J11) and the D pad cable (J15) from the upper PCA. See Diagram 6.3.
8. Remove the upper PCA by carefully unsnapping it from its mounts on the display front panel and slide it out of the two holding clips.
9. Position the replacement upper PCA at its mounting location on the display housing front panel, slide it into the two holding clips and press it into place in its mounts on the display front panel.
10. Reconnect heart rate PCA cable, the metrics PCA cable, the keypad cable and the D pad cable. See Diagram 6.3.
11. Remove the ground lead of the wrist strap from the EFX frame, then remove the wrist strap from your arm.
12. Skip to step 22.

Removing and replacing the HR PCA

13. Disconnect the HR input and output cables from the HR PCA. See Diagram 6.3.
14. Remove the HR PCA by carefully unsnapping it from its mounts on the display front panel.
15. Position the replacement HR PCA at its mounting location on the display housing front panel and press it into place in its mounts on the display front panel.
16. Reconnect the HR input and output cables to the HR PCA.
17. Skip to step 22.

Removing and replacing the Metrics PCA

18. Disconnect the metrics cable from the metrics PCA. See Diagram 6.3.
19. Remove the metrics PCA by carefully unsnapping it from its mounts on the display front panel.
20. Position the replacement metrics PCA at its mounting location on the display housing front panel and press it into place in its mounts on the display front panel.
21. Reconnect the metrics cable to the metrics PCA.
22. Position the accessory tray in its mounting position and fasten it with the screws removed in step 5, torque the screws to 6-9 inch pounds.
23. Position the display front panel on the display backplate. Replace and tighten the display mounting screws removed in step 6, torque the screws to 6-9 inch pounds.
24. Reconnect the data cable, with ferrite core, to rear of the upper PCA. Reconnect the heart rate cables. See Diagram 6.2.
25. Set the display bracket covers in their mounting position and fasten them with the screws removed in step 3., torque the screws to 6-9 inch pounds
26. Check operation as described in Section Four.

Procedure 7.3 - Replacing a Lower PCA

Warning: Care must be taken when work is being performed in the area of the stairarms. Pinch points exist between the stairarm and ramp and between the stairarm and crankarm, when the rear covers are removed.

Procedure

1. Set the on/off switch in the “off” position, then unplug the power cord from the A.C. outlet.

WARNING

Before continuing with this procedure, review the Warning and Caution statements listed in Section One, Things You Should Know.

2. Remove the access panel, top, left and right rear cover sections per Procedure 7.1.
3. Attach an antistatic wrist strap to your arm, then connect the ground lead of the wrist strap to the EFX frame ground or unpainted surface.
4. Remove the snap on cover from the lower PCA.
5. Disconnect the magnet cable (J1), the speed sensor cable (J8), the lift drive cable (J4), the lift position cable (J6), the data cable (J10), green-yellow ground wire and A.C. cables (J2 & J3) from the lower PCA. See Diagram 6.5.
6. Remove the screws that secure the lower PCA to the front cover section. Remove the lower PCA.
7. Position the replacement lower PCA at its mounting position on the front cover section. Fasten the lower PCA with the screws removed in step.6, torque the screws to 6-9 inch pounds.
8. Reconnect the data cable(J10), the speed sensor cable (J8), the lift drive cable (J4), the lift position cable (J6), the magnet cable (J1), green-yellow ground wire, the blue A.C. wire to J3 and the brown A.C. wire to J2.
9. Replace the snap on cover on the lower PCA.
10. Replace the left, right, top and access panel cover sections per Procedure 7.1.
11. Check operation as described in Section Four.

Procedure 7.4 - Replacing a Lower or Upper Data Cable

Procedure

Note: Before you install a new data cable, ensure that the data cable is defective. Refer to Procedure 6.1. The upper data cable is connected to the upper PCA at the rear of the display, and is then routed down the left outrigger tube. The upper data cable meets the lower data cable at the bottom of the left outrigger tube. The upper data cable is connected to the lower data cable via a coupler module. The lower data cable is routed through the frame from the bottom of the left outrigger tube to the lower PCA.

1. Set the on/off switch in the “off” position, then unplug the power cord from the A.C. outlet.

Replacing an Upper Data Cable

2. Remove the display bracket cover and disconnect the data cable from the upper PCA. See Diagram 6.2.
3. Carefully remove the left outrigger tube per Procedure 7.22 and carefully extract the cables and mid-point connector from the frame. Disconnect the upper data cable from the mid-point connector.
4. Tape one end of the replacement data cable to the display end of the existing data cable. Carefully pull the existing upper data cable out of the hole at the bottom of the left outrigger tube, as you feed the replacement data cable into the upper end of the left outrigger tube. Stop when the replacement data cable appears out of the hole in the frame near the rear of the ramp.
5. Remove the tape fastening the two data cables and discard the old data cable.
6. Reconnect the data cable to the rear of the upper PCA and replace the display bracket cover.
7. Connect the data cable to the mid-point connector, place the cables and mid-point connector in the frame.
8. Reinstall the left outrigger tube per Procedure 7.22.
9. Skip to step 18.

Replacing the Lower Data Cable

10. Remove the access panel, top, left and right cover sections per Procedure 7.1.
11. Carefully remove the left outrigger tube per Procedure 7.22 and carefully extract the cables and mid-point connector from the frame. Disconnect the lower data cable from the mid-point connector.
12. Disconnect the data cable from the lower PCA. See Diagram 6.5.

13. Tape the replacement lower data cable to the lower PCA end of the existing data cable. Carefully pull the existing lower data cable out of the hole in the frame, near the left outrigger tube, as you feed the replacement data cable into the frame. Stop when the replacement data cable appears out of the hole in the frame near the left outrigger tube.
14. Remove the tape fastening the two data cables and discard the old data cable.
15. Reconnect the data cable to the lower PCA.
16. Connect the data cable to the mid-point connector, place the cables and mid-point connector in the frame.
17. Reinstall the left outrigger tube per Procedure 7.22.
18. Replace the left, right, top and access panel rear cover sections per Procedure 7.1.
19. Check operation as described in Section Four.

Procedure 7.5 - Replacing a Power Entry Module

Procedure

Note: The power entry module on this EFX is a multifunction unit. It functions as a power entry module, A.C. line fuse holder, on/off switch and A.C. line filter.

1. Set the on/off switch in the off position. Remove the A.C. line cord from the A.C. outlet and from the power entry module.
2. Remove the access panel, top, left and right cover sections per Procedure 7.1.

Diagram 7.5 - Power Entry Module

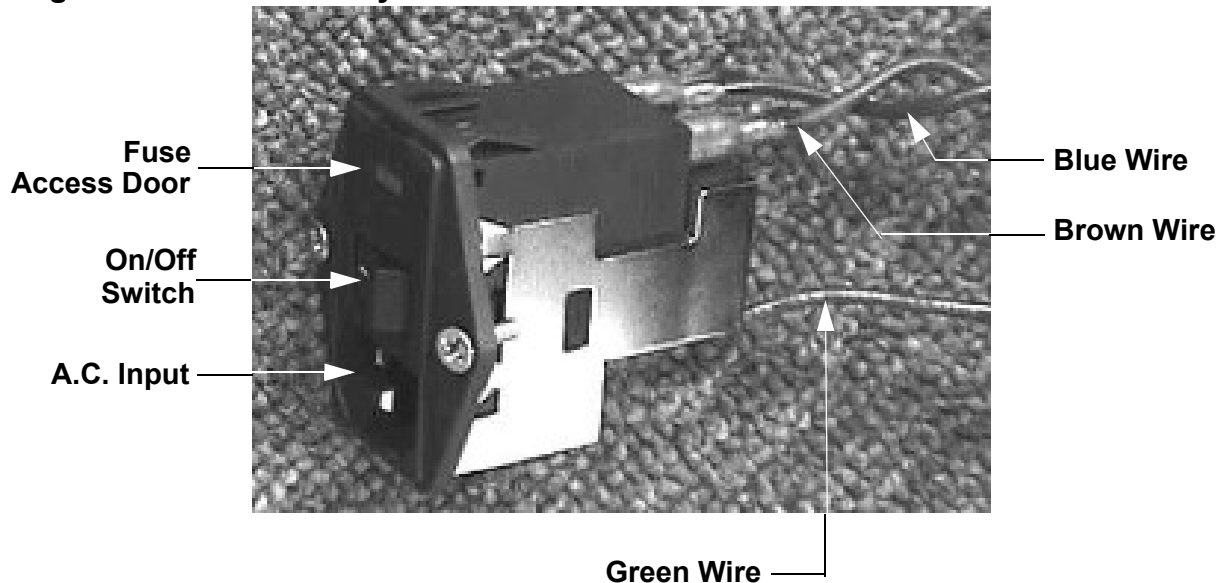

3. Remove the blue wire from terminal D, the brown wire from terminal A and the green wire from the ground terminal of the power entry module.
4. Remove the two screws that fasten the power entry module to the bottom cover. Remove the power entry module from the bottom cover.
5. Open the fuse compartment and remove both fuses (See Procedure 7.24). Check both fuses with an ohmmeter. They should read approximately 1Ω or less. Replace any fuse that reads significantly high.
6. Install the tested fuses, from step 5, in the replacement power entry module.

7. Set the replacement power entry module at its mounting position, secure the power entry module with the screws removed in step 4, torque the screws to 6-9 inch pounds.
8. Replace the wires removed in step 3. Connect the blue wire to terminal D, the brown wire to terminal A and the green wire to the ground terminal of the power entry module.
9. Replace the left, right, top and access panel cover sections per Procedure 7.1.
10. Insert the A.C. line cord in the power entry module and the A.C. outlet.
11. Set the on/off switch in the on position and test the EFX per Section Four.

Procedure 7.6 - Replacing a Crankarm Assembly

Warning: Care must be taken when work is being performed in the area of the stairarms. Pinch points exist between the stairarm and ramp and between the stairarm and crankarm, when the rear covers are removed.

Procedure

1. Set the on/off switch in the “off” position, then unplug the power cord from the A.C. outlet.

WARNING

Before continuing with this procedure, review the Warning and Caution statements listed in Section One, Things You Should Know.

2. Remove the access panel, top, left and right cover sections as described in Procedure 7.1.
3. Remove the left and/or right stairarm assembly as described in Procedure 7.17.

Note:

Notice the position of the two crank arms. When the crankarms are replaced, they must be positioned so that they are 180 degrees opposing.

4. Remove the bolt that secures the crankarm to the input pulley shaft. It will be necessary to use a Pitman arm puller or 4” to 6” gear puller to remove the crankarm. Do not use a hammer or mallet to remove the crankarm.
5. If you are removing both crank arm assemblies, repeat Steps 3 and 4 for the second crankarm assembly.

Diagram 7.6 - Crankarm



6. Clean the crankarm mounting bolt threads and the input pulley shaft threads with an alcohol swab. Allow them to dry and apply blue loctite to the crankarm mounting bolt threads.
7. Position the crankarm on the input pulley shaft. Thread and hand tighten the crankarm mounting bolt into the input pulley shaft. Torque the bolt to 300 inch pounds (25 foot pounds).
8. Replace the stairarm assembly as described in Procedure 7.17.
9. If you are replacing both crankarm assemblies, repeat steps 6,7 and 8 for the second crankarm assembly.
10. Set the unit at it's highest resistance setting and use the EFX for a minimum of 3 minutes. Stride in a forward direction for half of the time and in a backward direction for half of the time. Set the on/off switch in the "off" position and re-torque both of the crankarm mounting bolts to 300 inch pounds (25 foot pounds).
11. Replace the left, right, top and access panel cover sections per Procedure 7.1.

Procedure 7.7 - Replacing a Pillow Block Bearing

Warning: Care must be taken when work is being performed in the area of the stairarms. Pinch points exist between the stairarm and ramp and between the stairarm and crankarm, when the rear covers are removed.

Procedure

1. Set the on/off switch in the off position, then unplug the power cord from the A.C. outlet.
2. Remove the access panel, top, left and right cover sections as described in Procedure 7.1.
3. Remove both stairarm assemblies per Procedure 7.17.
4. Remove the crankarm from the same side as the pillow block bearing that you are replacing.
5. Mark the current position of the step up belt tension bolts and the position of the idler pulley mounting bolt in its adjustment slot with a pen or white out. This will enable you to recreate the existing tension settings later in this procedure. See Diagram 5.3.
6. Remove tension from the input pulley and step-up pulley belts as described below:
 - a. Loosen the idler pulley axle bolt and turn the input belt tensioner adjustment nuts counterclockwise until tension is removed from the input belt. (See Diagram 5.3).
 - b. Straighten the locking tabs and turn the left and right tension bolts counterclockwise until tension is removed from the step up belt. (See Diagram 5.3).
 - c. Slide the input and step up belts off of their pulleys.
7. The pillow block bearing will have manufacture's information stamped into one side of the pillow block bearing's housing. The two pillow block bearings must be mounted so that one pillow block bearing has the stamping on the topside and one pillow block bearing has stamping on the bottom side. Note the orientation of the stamping on the pillow block bearing that you are replacing. See Diagram 7.7. Remove the pillow block mounting bolts that fasten the pillow block bearing to the drive weldment upright. Remove the pillow block bearing from the input pulley shaft and discard.
8. Slide the replacement pillow block bearing onto the input pulley shaft with the orientation noted in step 7.
9. Thread and hand tighten the pillow block mounting bolts into the drive weldment upright. Torque the pillow block mounting bolts to 120 inch pounds (10 foot pounds).
10. Tighten the right and left hand step up belt tension bolts and the idler pulley mounting bolt to the settings marked in step 5.
11. Verify the tension of the belts per Procedure 5.2.

12. Replace the crankarm(s) per Procedure 7.6.

Diagram 7.7 - Pillow Block Bearings

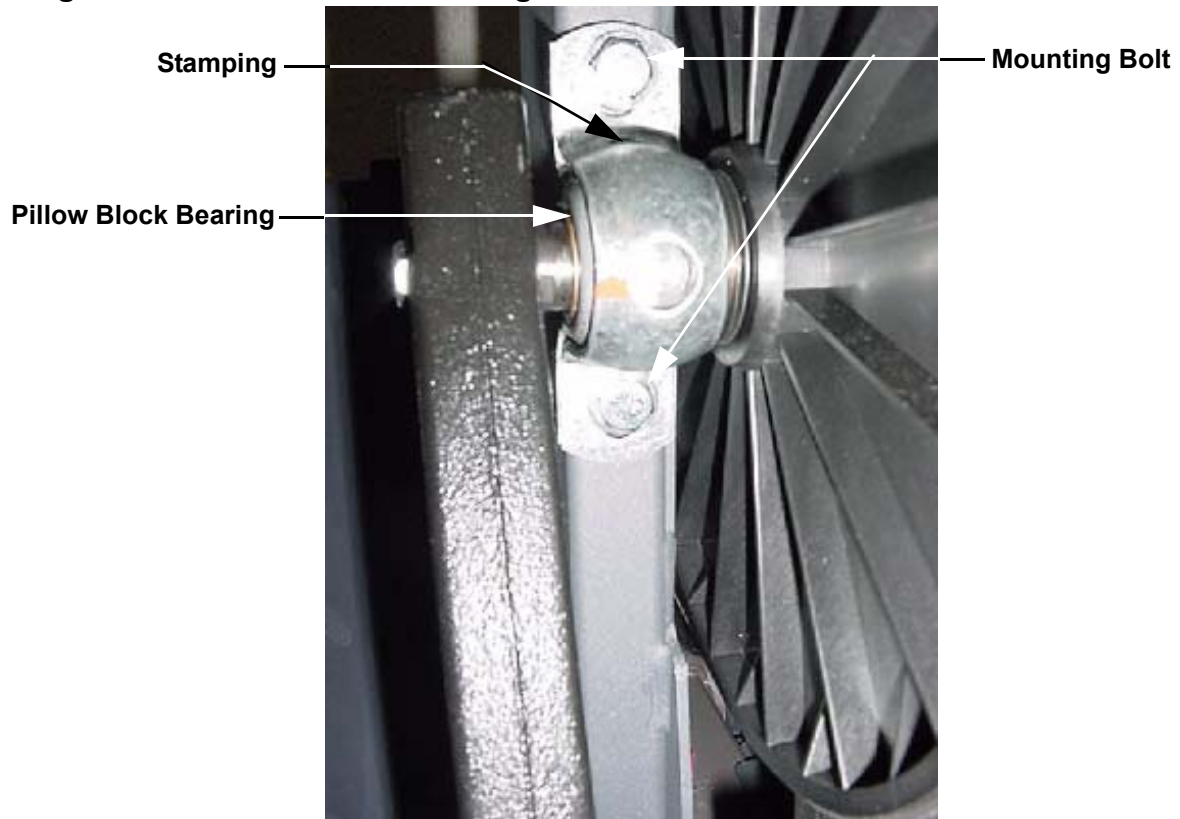

13. Replace the stairarms per Procedure 7.17.

14. Check drive input adjustment per Procedure 5.4.

15. Replace the access panel, top, left and right cover sections per Procedure 7.1.

16. Check EFX operation per Section 4.

Procedure 7.8 - Replacing an Input Drive Assembly

Warning: Care must be taken when work is being performed in the area of the stairarms. Pinch points exist between the stairarm and ramp and between the stairarm and crankarm, when the rear covers are removed.

Procedure

Note: The input drive assembly consists of the input pulley assembly and eddy current disk assembly.

1. Set the on/off switch in the “off” position, then unplug the power cord from the wall outlet.

WARNING

Before continuing with this procedure, review the Warning and Caution statements listed in Section One, Things You Should Know.

2. Remove the access panel, top, left and right cover sections as described in Procedure 7.1.
3. Remove the stairarm assemblies as described in Procedure 7.17.
4. Remove the crankarm assemblies as described in Procedure 7.6.
5. Mark the current position of the step up belt tension bolts and the position of the idler pulley mounting bolt in its adjustment slot with a pen or white out. This will enable you to recreate the existing tension settings later in this procedure. See Diagram 5.3. Remove tension from the drive belts and remove the pillow block bearings per Procedure 7.7.
6. Slide the step up and input belts off of the input drive assembly and remove the input drive assembly from the EFX. (See Diagrams 7.8).

Diagram 7.8 - Eddy Current Disk

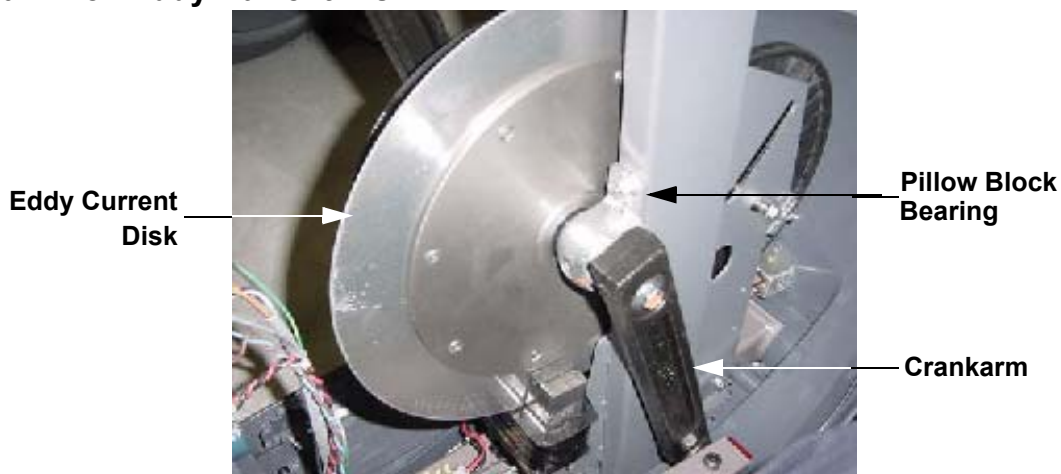

7. Slide the step up and input belts onto the replacement input drive assembly as you set the input drive assembly in its mounting position in the EFX.
8. Thread and hand tighten the pillow block mounting bolts into the drive weldment upright. Torque the pillow block mounting bolts to 120 inch pounds (10 foot pounds) starting with the bottom left hand bolt, then the bottom right hand bolt, the upper right hand bolt and then the upper left hand bolt.
9. Tighten the right and left hand step up belt tension bolts and the idler pulley mounting bolt to the settings marked in step 5.
10. Verify the tension of the belts per Procedure 5.2.
11. Replace the crankarm(s) per Procedure 7.6
12. Replace the stairarms per Procedure 7.17.
13. Check drive input adjustment per Procedure 5.4.
14. Replace the access panel, top, left and right cover sections per Procedure 7.1
15. Check EFX operation per Section 4.

Procedure 7.9 - Replacing an Input Pulley Belt

Warning: Care must be taken when work is being performed in the area of the stairarms. Pinch points exist between the stairarm and ramp and between the stairarm and crankarm, when the rear covers are removed.

1. Procedure

1. Set the on/off switch in the "off" position, then unplug the power cord from the A.C. outlet.

WARNING

Before continuing with this procedure, review the Warning and Caution statements listed in Section One, Things You Should Know.

2. Remove the access panel, top, left and right cover sections as described in Procedure 7.1.
3. Remove the stairarm assemblies as described in Procedure 7.17.
4. Remove the crankarm assemblies as described in Procedure 7.6.
5. Mark the current position of the step up belt tension bolts and the position of the idler pulley mounting bolt in its adjustment slot with a pen or white out. This will enable you to recreate the existing tension settings later in this procedure. See Diagram 5.3.
6. Remove tension from the drive belts and remove the pillow block bearings per Procedure 7.7.
7. Slide the step up and input belts off of the input drive assembly and remove the input drive assembly from the unit. (See Diagrams 7.5)
8. Remove the left and right tension bolts, locking tabs and brackets. Slide the step up pulley assembly with both the step up and input belts out of the drive unit.

Diagram 7.9 - Step Up Pulley



9. Remove the input pulley belt and place the replacement input pulley belt in its place on the step up pulley assembly.
10. Set the step up pulley assembly with the step up and input belt at its mounting position in the drive unit. Replace the tensioning bolts, locking tabs and brackets removed in step 8. Thread the left and right tension bolts into the step up pulley shaft.
11. Slide the step up and input belts onto the input drive assembly as you set the input drive assembly in its mounting position in the drive unit.
12. Slide the pillow block bearings onto the input pulley shaft with the stamping on one pillow block bearing on top and the stamping on one pillow block bearing on the bottom. See Diagram 7.7.
13. Thread and hand tighten the pillow block mounting bolts into the drive weldment upright. Torque the pillow block mounting bolts to 120 inch pounds (10 foot pounds).
14. Tighten the right and left hand tension bolts and using a stout screwdriver as a lever, press the idler pulley to the right. to remove most of the slack from the belt, tighten the idler puller axle bolt.
15. Tighten the right and left hand step up belt tension bolts and the idler pulley mounting bolt to the settings marked in step 5.
16. Verify the tension of the belts per Procedure 5.2.
17. Replace the crankarm(s) per Procedure 7.6
18. Replace the stairarms per Procedure 7.17.
19. Check drive input adjustment per Procedure 5.4.
20. Replace the access panel, top, left and right cover sections per Procedure 7.1.
21. Check EFX operation per Section 4.

Procedure 7.10 - Replacing a Step-Up Pulley Belt

Warning: Care must be taken when work is being performed in the area of the stairarms. Pinch points exist between the stairarm and ramp and between the stairarm and crankarm, when the rear covers are removed.

1. Procedure

1. Set the on/off switch in the "off" position, then unplug the power cord from the wall outlet.

WARNING

Before continuing with this procedure, review the Warning and Caution statements listed in Section One, Things You Should Know.

2. Remove the access panel, top, left and right cover sections as described in Procedure 7.1.
3. Remove the stairarm assemblies as described in Procedure 7.17.
4. Remove the crankarm assemblies as described in Procedure 7.6.
5. Mark the current position of the step up belt tension bolts and the position of the idler pulley mounting bolt in its adjustment slot with a pen or white out. This will enable you to recreate the existing tension settings later in this procedure. See Diagram 5.3
6. Remove tension from the drive belts and remove the pillow block bearings per Procedure 7.7.
7. Remove the input drive assembly from the unit. per Procedure 7.8.
8. Remove the left and right tension bolts, locking tabs and brackets. Slide the step up pulley assembly with both the step up and input belts out of the drive unit.
9. Remove the step up pulley belt and place the replacement step up pulley belt in its mounting position on the step up pulley assembly.
10. Set the step up pulley assembly with the step up and input belt at its mounting position in the drive unit. Replace the tensioning bolts, locking tabs and brackets removed in step 8. Thread the left and right tension bolts into the step up pulley shaft.
11. Slide the step up and input belts onto the input drive assembly as you set the input drive assembly in its mounting position in the drive unit.
12. Slide the pillow block bearings onto the input pulley shaft.
13. Thread and hand tighten the pillow block mounting bolts into the drive weldment upright. Torque the pillow block mounting bolts to 120 inch pounds (10 foot pounds).

14. Tighten the right and left hand step up belt tension bolts and the idler pulley mounting bolt to the settings marked in step 5.
15. Verify the tension of the belts per Procedure 5.2.
16. Replace the crankarm(s) per Procedure 7.6
17. Replace the stairarms per Procedure 7.17.
18. Check drive input adjustment per Procedure 5.4.
19. Replace the access panel, top, left and right cover sections per Procedure 7.1.
20. Check EFX operation per Section 4.

Procedure 7.11 - Replacing a Step-Up Pulley Assembly

Warning: Care must be taken when work is being performed in the area of the stairarms. Pinch points exist between the stairarm and ramp and between the stairarm and crankarm, when the rear covers are removed.

Procedure

1. Set the on/off switch in the “off” position, then unplug the power cord from the wall outlet.

WARNING

Before continuing with this procedure, review the Warning and Caution statements listed in Section One, Things You Should Know.

2. Remove the access panel, top, left and right cover sections as described in Procedure 7.1.
3. Remove the stairarm assemblies as described in Procedure 7.17.
4. Remove the crankarm assemblies as described in Procedure 7.6.
5. Mark the current position of the step up belt tension bolts and the position of the idler pulley mounting bolt in its adjustment slot with a pen or white out. This will enable you to recreate the existing tension settings later in this procedure. See Diagram 5.3
6. Remove tension from the drive belts.
7. Slide the step up and input belts off of their pulleys.
8. Remove the left and right tension bolts, locking tabs and brackets.
9. Loosen the step up pulley axle nuts and slide the step up pulley assembly with both the step up and input belts out of the drive unit.
10. Place the step up and input belts on the replacement step up pulley assembly.
11. Set the replacement step up pulley assembly with the step up and input belt at it's mounting position in the unit. Replace the tensioning bolts, locking tabs and brackets removed in step 8. Thread the left and right tension bolts into the step up pulley shaft.
12. Slide the step up and input belts onto the input drive assembly as you set the input drive assembly in its mounting position in the unit.
13. Slide the pillow block bearings onto the input pulley shaft.
14. Thread and hand tighten the pillow block mounting bolts into the drive weldment upright. Torque the pillow block mounting bolts to 120 inch pounds (10 foot pounds).

15. Tighten the right and left hand step up belt tension bolts and the idler pulley mounting bolt to the settings marked in step 5.
16. Verify the tension of the belts per Procedure 5.2
17. Torque the step up pulley axle nuts to 480 inch pounds (40 foot pounds)
18. Replace the crankarm(s) per Procedure 7.6
19. Replace the stairarms per Procedure 7.17.
20. Check drive input adjustment per Procedure 5.4.
21. Replace the access panel, top, left and right cover sections per Procedure 7.1.
22. Check EFX operation per Section 4.

Procedure 7.12 - Replacing a Speed Sensor Assembly

Procedure

1. Set the on/off switch in the "off" position, then unplug the power cord from the wall outlet.

WARNING

Before continuing with this procedure, review the Warning and Caution statements listed in Section One, Things You Should Know.

2. Remove the access panel, top, left and right cover sections as described in Procedure 7.1.
3. Remove the snap on cover from the lower PCA.
4. Disconnect the speed sensor cable from the J8 connector on the lower PCA. See Diagram 6.5.
5. Unsnap the speed sensor from the speed sensor bracket and remove the speed sensor. See Diagram 7.9.

Diagram 7.9- Speed Sensor

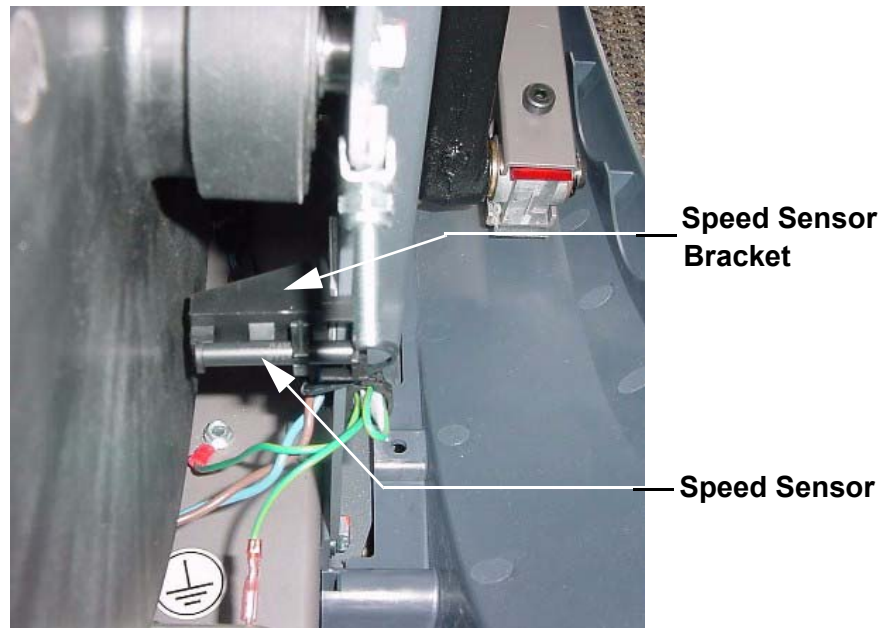

6. Snap the replacement speed sensor into the speed sensor bracket. See Diagram 7.9.
7. Reconnect the speed sensor cable to the J8 connector on the lower PCA.
8. Replace the snap on cover on the lower PCA.
9. Re-install the left, right, top and access panel cover sections as described in Procedure 7.1.
10. Check the operation of the EFX per Section Four.

Procedure 7.13 - Replacing an Eddy Current Magnet Assembly

Procedure

1. Set the on/off switch in the "off" position, then unplug the power cord from the wall outlet.

WARNING

Before continuing with this procedure, review the Warning and Caution statements listed in Section One, Things You Should Know.

2. Remove the access panel, top, left and right cover sections as described in Procedure 7.1.
3. Disconnect the magnet cable from the magnet assembly. See Diagram 7.10.
4. Remove the bolts that secure the magnet assembly to the drive unit. Remove the magnet from the drive unit.
5. Position the replacement magnet assembly at its mounting position so that the eddy current disk is centered between the magnet's poles.
6. Replace and hand tighten the magnet assembly mounting bolts. Torque the magnet assembly mounting bolts to 66 inch pounds.
7. Reconnect the magnet cable to the magnet assembly.
8. Re-install the left, right, top and access panel cover sections as described in Procedure 7.1, then check the operation of the EFX as described in Section Four.

Diagram 7.10 - Eddy Current Magnet)



Procedure 7.14 - Replacing a Stairarm Pivot Block

Warning: Care must be taken when work is being performed in the area of the stairarms. Pinch points exist between the stairarm and ramp and between the stairarm and crankarm, when the rear covers are removed.

Procedure

1. Set the on/off switch in the "off" position, then unplug the power cord from the wall outlet.

WARNING

Before continuing with this procedure, review the Warning and Caution statements listed in Section One, Things You Should Know.

2. Remove the access panel, top, left and right cover sections as described in Procedure 7.1.
3. If the moveable arm's connecting link is attached to the stairarm, remove it from the stairarm and attach it to its storage point on the frame.
4. Remove the mounting bolt and nut that fastens the stairarm pivot block to the stairarm. See Diagram 7.11.
5. Slide the stairarm off of the stairarm pivot block.
6. Remove the stairarm pivot block retaining ring, flat washer and wave washer from the crankarm pin. Slide the stairarm pivot block off of the crankarm pin. If the stairarm pivot block is being replaced because of excessive wear, check the condition of the crankarm pin, and spacers, it may be necessary to replace them.

Diagram 7.11 - Stairarm Mounting

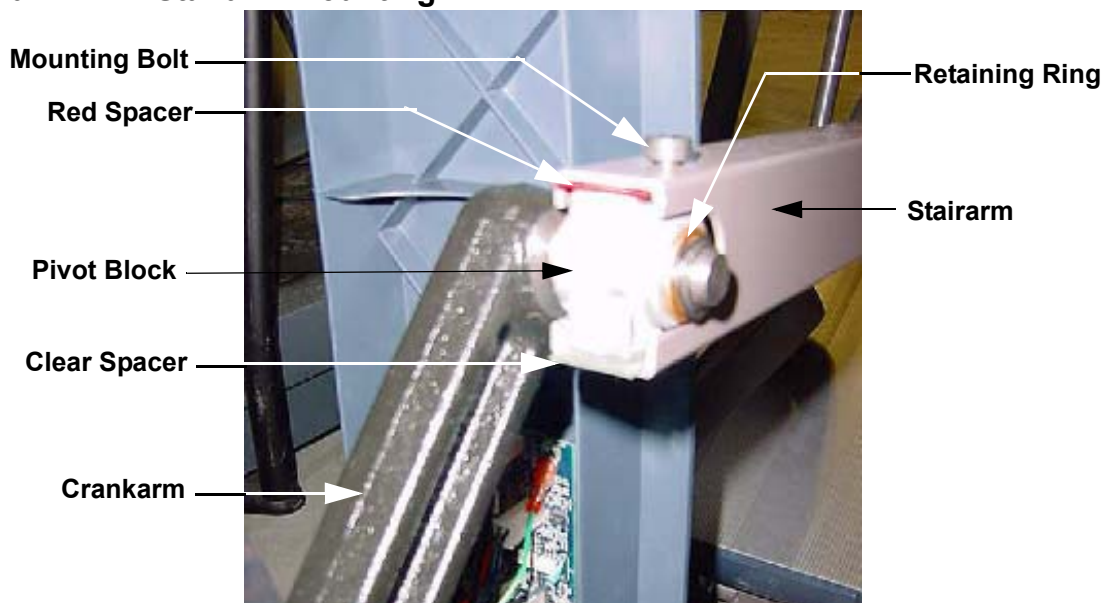

7. Slide the stairarm pivot block onto the crankarm pin and replace the wave washer, flat washer and retaining ring removed in step 6.
8. Slide the stairarm onto the stairarm pivot block. Ensure that the red spacer is on the top and the clear spacer is on the bottom of the pivot block as shown in Diagram 7.11. Install and hand tighten the stairarm pivot block mounting hardware. The mounting bolt head must be on the top of the stairarm as shown in Diagram 7.11. Torque the stairarm pivot block mounting bolt to 180 inch pounds (15 ft./lbs).
9. Replace the left, right, top and access panel cover sections per Procedure 7.1.
10. Check EFX operation per Section 4.

Procedure 7.15 - Replacing a Wheel Assembly

Warning: Care must be taken when work is being performed in the area of the stairarms. Pinch points exist between the stairarm and ramp and between the stairarm and crankarm, when the rear covers are removed.

Procedure

1. Set the on/off switch in the "off" position, then unplug the power cord from the wall outlet.

WARNING

Before continuing with this procedure, review the Warning and Caution statements listed in Section One, Things You Should Know.

2. Remove the access, top, left and right cover sections as described in Procedure 7.1
3. If the moveable arm's connecting link is attached to the stairarm, remove it from the stairarm and attach it to its storage point on the frame. See Diagram 7.17.
4. Remove the stairarm pivot block retaining ring, flat washer and wave washer from the crankarm pin. See Diagram 7.11
5. Remove the stairarm from the crankarm and roll the stairarm off of the rear of the ramp.

Diagram 7.12- Wheel Assembly



6. Remove the screws that fasten the two retainers to the stairarm. Remove the wheel and discard.
7. Set the replacement wheel in its mounting position and fasten it with the retainers and screws removed in step 5. Torque the screws to 60 inch pounds.

8. Roll the stairarm into the ramp channel from the rear of the ramp. Slide the stairarm pivot block onto the crankarm pin and replace the wave washer, flat washer and retaining ring removed in step 3.
9. Replace the left, right, top and access panel cover sections per Procedure 7.1.
10. Check EFX operation per Section 4.

Procedure 7.16 - Replacing a Stairarm Pedal

Warning: Care must be taken when work is being performed in the area of the stairarms. Pinch points exist between the stairarm and ramp and between the stairarm and crankarm, when the rear covers are removed.

1. Procedure

1. Set the on/off switch in the "off" position, then unplug the power cord from the wall outlet
2. Remove the four palnuts that fasten the pedal to the stairarm. Remove the pedal from the stairarm. There are two strips of double sided tape between the pedal and the stairarm, so there will be some resistance when you remove the pedal.
3. Remove the two strips of double sided tape and replace them with two new strips of double sided foam tape, Precor part number [39874-101](#).

Diagram 7.13 - Stairarm Pedal, Viewed from the Bottom of the Stairarm

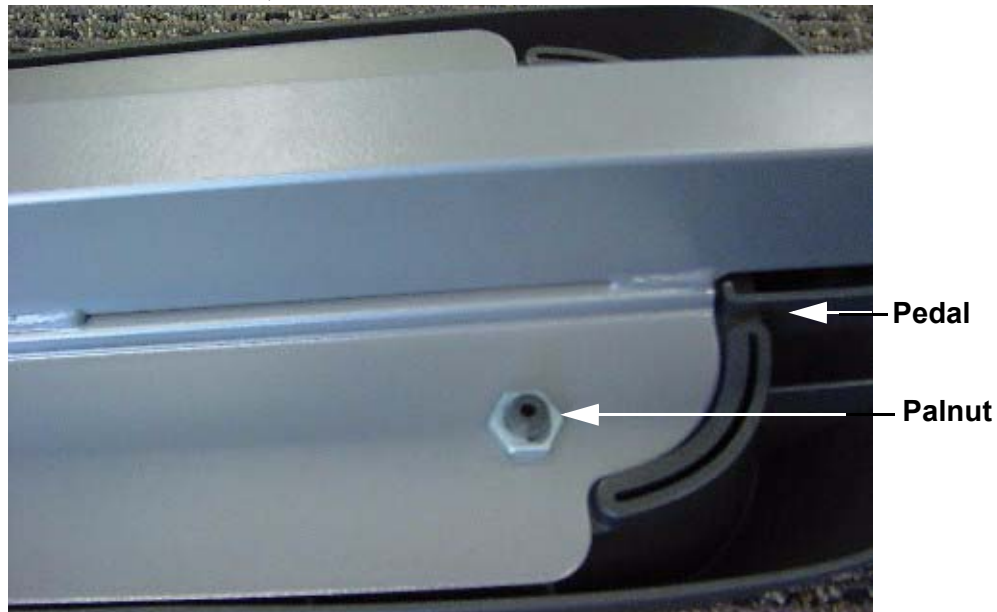

4. Set the pedal in its mounting position on the stairarm and fasten it with the four palnuts removed in step 2. The palnuts will cut new threads in the pedals plastic studs. Torque the palnuts to 6-9 inch pounds.

Procedure 7.17 - Replacing a Stairarm

Warning: Care must be taken when work is being performed in the area of the stairarms. Pinch points exist between the stairarm and ramp and between the stairarm and crankarm, when the rear covers are removed.

1. Procedure

1. Set the on/off switch in the "off" position, then unplug the power cord from the wall outlet.
2. Remove the access panel, top, left and right cover sections as described in Procedure 7.1.
3. If the moveable arm's connecting link is attached to the stairarm, remove it from the stairarm and attach it to its storage point on the frame
4. Remove the mounting bolt and nut that fastens the stairarm pivot block to the stairarm.
5. Slide the stairarm off of the stairarm pivot block.
6. Roll the stairarm out of the rear of the ramp.
7. Remove and stairarm pedal from the existing stairarm and install it on the replacement stairarm per Procedure 7.16.
8. Remove and stairarm wheel from the existing stairarm and install it on the replacement stairarm per procedure 7.15
9. Roll the stairarm into the ramp channel from the rear of the ramp.
10. Slide the stairarm onto the stairarm pivot block. Ensure that the red spacer is on the top and the clear spacer is on the bottom of the pivot block as shown in Diagram 7.11. Install and hand tighten the stairarm pivot block mounting hardware. The mounting bolt head must be on the top of the stairarm as shown in Diagram 7.11. Torque the stairarm pivot block mounting bolt to 15 ft./lbs.
11. If the moveable arm's connecting link was moved from the stairarm to its storage point in step 3, re-install the connecting link on the stairarm.
12. Replace the left, right, top and access panel cover sections per Procedure 7.1.
13. Check EFX operation per Section 4.

Procedure 7.18 - Replacing a Ramp Assembly

Warning: Care must be taken when work is being performed in the area of the stairarms. Pinch points exist between the stairarm and ramp and between the stairarm and crankarm, when the rear covers are removed.

1. Set the on/off switch in the “on” position. Press the **QUICK START** key, while striding on the unit raise the incline to its maximum position.
2. Set the on/off switch in the “off” position, then unplug the power cord from the wall outlet.
3. Remove the access panel, top, right and left rear covers per Procedure 7.1
4. Remove both stairarms per procedure 7.17.
5. Remove the two bolts that fasten the lower rear portion of the ramp to the frame. See Diagram 7.14.

Diagram 7.14 - Lower Ramp Mounting



6. Remove the two bolts that fasten the upper end of the ramp to the lift motor yoke. See Diagram 7.15.
7. Carefully lift the ramp and slide it off of the lift motor yoke.
8. Slide the replacement ramp onto the lift motor yoke and hand start the two lower ramp mounting bolts removed in step 5. Fasten the upper end of the ramp to the lift motor yoke with the hardware removed in step 6. Torque the two lower ramp bolts to 480 inch pounds (40 foot pounds).

Diagram 7.15 - Upper Ramp Mounting

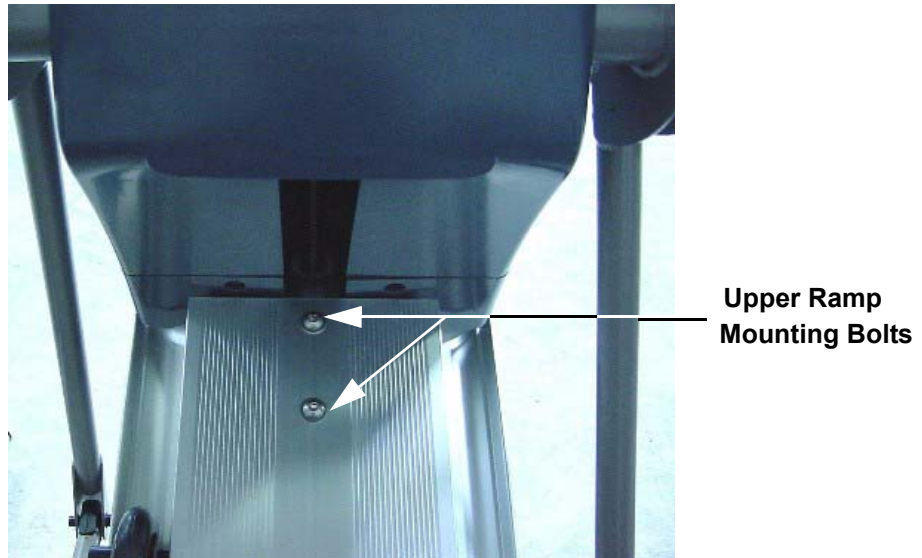

9. Replace both stairarms per Procedure 7.12.
10. Replace the left, right, top and access panel cover sections per Procedure 7.1.
11. Check EFX operation per Section 4.

Procedure 7.19 - Replacing a Moveable Handlebar

1. Set the on/off switch in the "off" position, then unplug the power cord from the wall outlet.
2. Remove the bolt that fasten the forward end of the connecting link to the moveable handlebar. See Diagram 7.16

Diagram 7.16 - Moveable Handlebar, Lower End



3. The rearward end of the connecting link will either be attached to the stairarm or to its storage point on the frame. Depress the orange button and remove the connecting link. Removing the connecting link prevents it from resting on the outrigger tube and will prevent the painted surfaces of the outrigger tube and connecting link from damage.

Diagram 7.17 - Handlebar Connecting Link

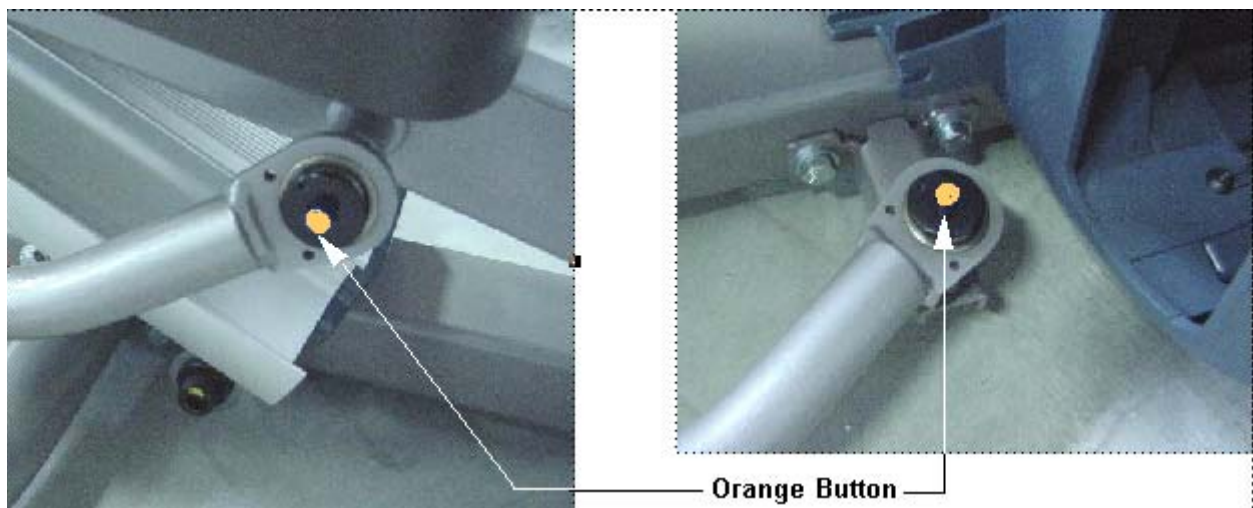

4. Remove the outrigger tube per Procedure 7.22.
5. Using a 1/2 inch wrench the moveable handlebar's axle, unscrew and remove the moveable handlebar. See Diagram 7.18.

Diagram 7.18 - Moveable Handlebar

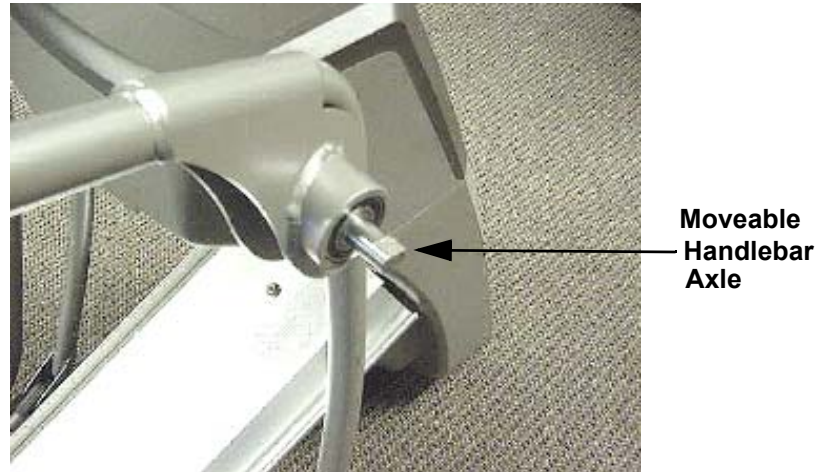

6. Set the replacement moveable handlebar in its mounting position. Carefully start hand threading the moveable handlebar to avoid cross threading and then tighten.
7. Replace the outrigger tube per Procedure 7.22.
8. Set the connecting link in its mounting at the lower end of the moveable handlebar and fasten it with the hardware removed in step 2.
9. Depress the orange button on the rearward end of the connecting link and install on it either the stairarm or its storage point as required.
10. Check EFX operation per Section 4.

Procedure 7.20 - Replacing a Idler Pulley

Warning: Care must be taken when work is being performed in the area of the stairarms. Pinch points exist between the stairarm and ramp and between the stairarm and crankarm, when the rear covers are removed.

Procedure

1. Set the on/off switch in the "off" position, then unplug the power cord from the wall outlet.

WARNING

Before continuing with this procedure, review the Warning and Caution statements listed in Section One, Things You Should Know.

2. Remove the access panel, top, left and right cover sections as described in Procedure 7.1.
3. Mark the current position of the idler pulley mounting bolt in its adjustment slot with a pen or white out. This will enable you to recreate the existing tension setting later in this procedure. See Diagram 7.19
4. Remove the idler pulley axle bolt and slide the idler pulley out of the frame.

Diagram 7.19 - Input Belt Tensioner

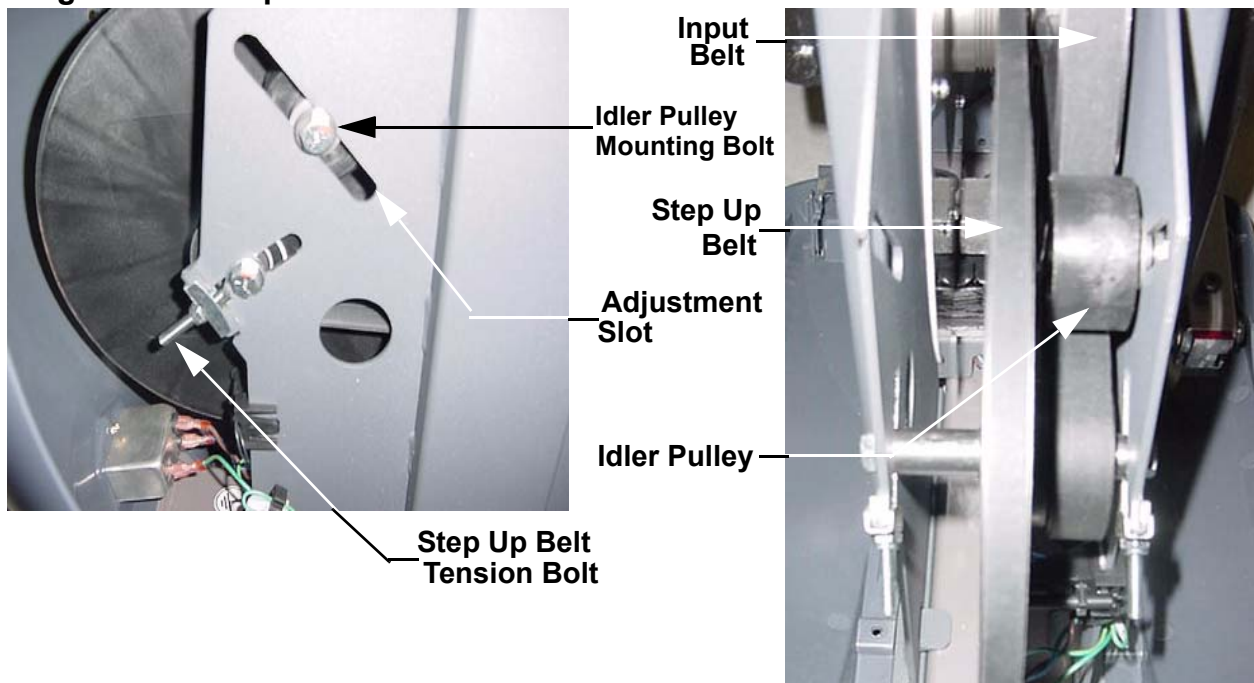

5. Tighten the idler pulley mounting bolt to the settings marked in step 3. Torque the idler pulley mounting bolt to 120 inch pounds (10 foot pounds).
6. Verify the tension of the belts per Procedure 5.2.
7. Replace the left, right, top and access panel cover sections per Procedure 7.1.

Procedure 7.21 - Replacing a Front Cover Section

1. Set the on/off switch in the "off" position, then unplug the power cord from the wall outlet.
2. It is only necessary to perform as much of this procedure as is required to access the cover being replaced.
3. Grasp the upper front cover section and lift upwards to remove it. See Diagram 7.20

Diagram 7.20 - Front Covers

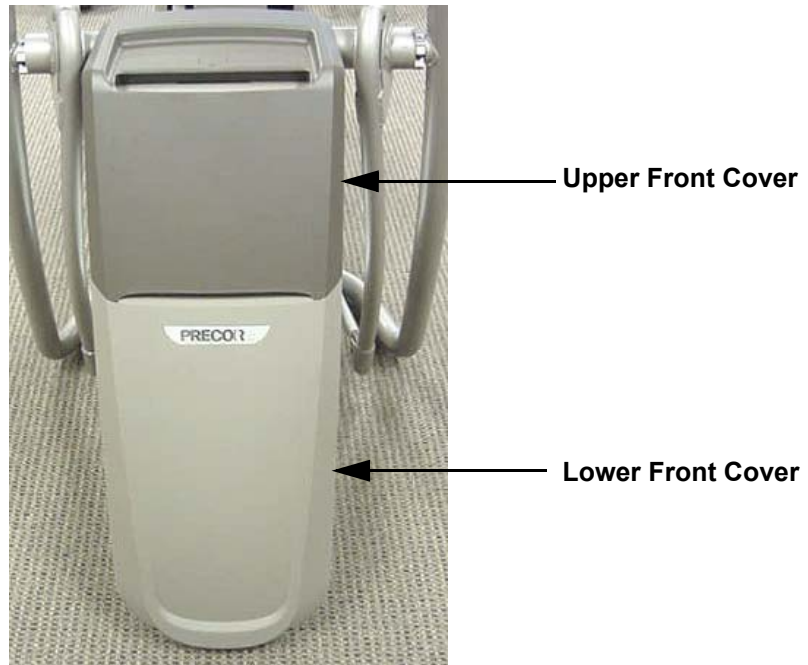

4. Remove the four screws that fasten the top cover section. See Diagram 7.21.

Diagram 7.21 - Top Cover with Upper Front Cover Removed

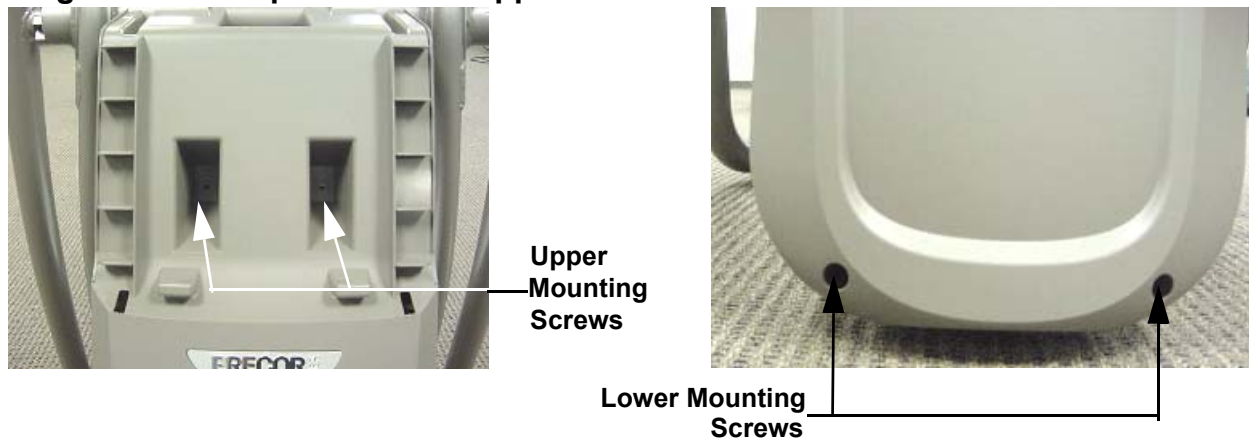

5. The lower rear cover must be removed before the upper rear cover. Plug the power cord in the A.C. outlet and set the on/off switch in the “on” position. Lower the incline to its lowest position.
6. Remove the two screws in the upper portion of the lower rear cover. Slide the rear cover rearward and off of the EFX. See Diagram 7.23.

Diagram 7.22 - Lower Rear Cover, Rear View

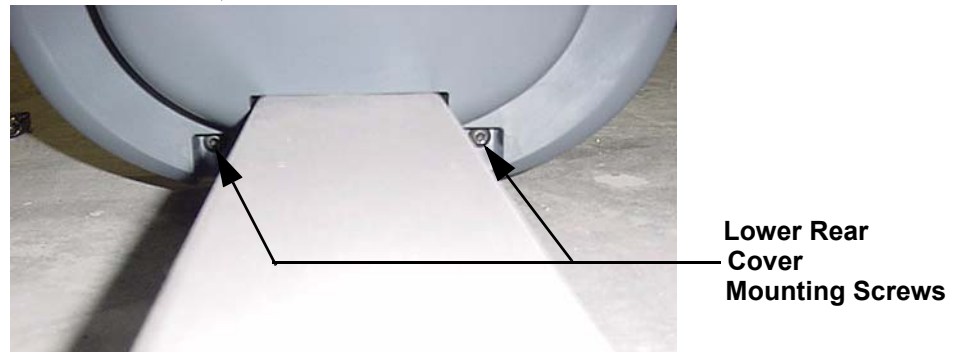

7. Raise the incline to its highest position. Remove the two screws from the rear of the lower portion of the rear cover. See Diagram 7.22.

Diagram 7.23 - Upper Rear Cover, Rear View

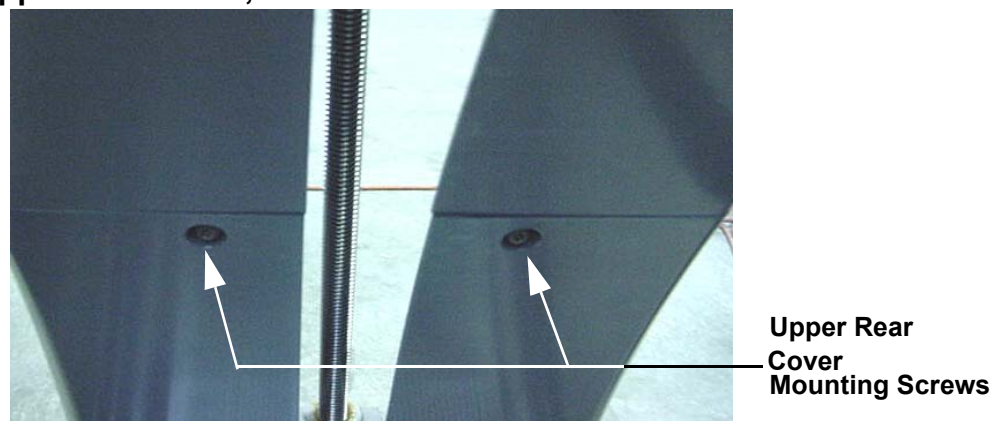

8. Lower the incline to its lowest position, set the upper rear cover in its mounting position and fasten it with the two screws removed in step 7.
9. Raise the incline to its highest position and set the lower rear cover in its mounting position and fasten it with the screws removed in step 6, torque the screws to 6-9 inch pounds.
10. Set the on/off switch in the “off” position, then unplug the power cord from the wall outlet.
11. Set the lower front cover in its mounting position ensuring that the tabs in the lower front cover align with the pockets in the lower and upper rear covers. Snap the front cover into place and fasten it with the screws removed in step 4, torque the screws to 6-9 inch pounds.
12. Set the upper front cover in its mounting position and snap it into place.

Procedure 7.22 - Replacing an Outrigger Tube

1. Set the on/off switch in the "off" position, then unplug the power cord from the wall outlet.
2. Remove the display bracket cover from the rear of the display.
3. Carefully, lift the front of the EFX and place it on a temporary support, such as a block of wood. This is necessary to remove the EFX's weight from the outrigger tube. Before proceeding with procedure, be sure that the EFX is in a solid stable position and will not tip or fall off of the temporary support.
4. Remove the three bolts from the upper end of the outrigger tube and four bolts from the lower end of the outrigger tube. See Diagram 7.24.

Diagram 7.24 - Outrigger Tube Mounting

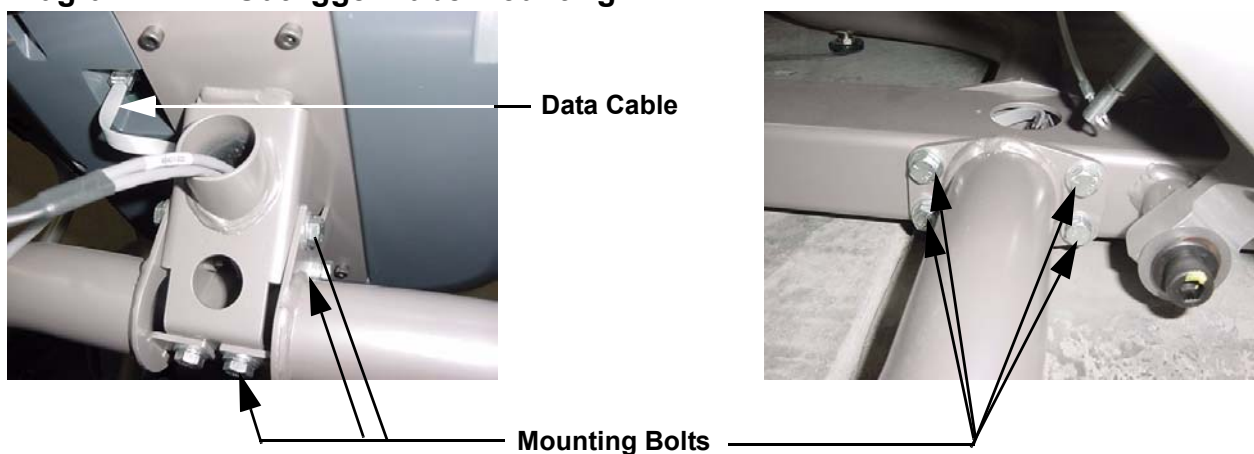

5. Loosen but do not remove the two clamp bolts at the handlebar pivot point. See Diagram 7.25.

Diagram 7.25 - Outrigger Tube Mounting

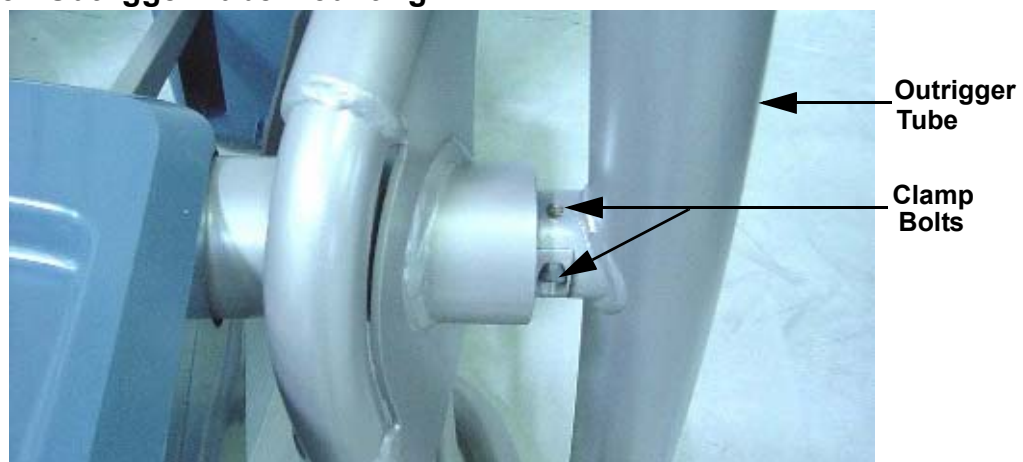

6. If you are removing the right hand outrigger tube, skip to step 10. If you are removing the left hand outrigger tube, continue with step 7.
7. Disconnect the data cable from the upper printed circuit board. If applicable, disconnect the heart rate cables. See Diagram 6.2.
8. Carefully remove the outrigger tube from the EFX. The data cable is still connected to the mid-point connector and the lower end of the outrigger tube.
9. Disconnect the data cable from the mid-point connector.
10. If you are removing the right hand outrigger tube, skip to step 13. If you are removing the left hand outrigger tube, continue with step 11.
11. Remove the data cable from the old outrigger tube and feed it into the replacement outrigger tube.
12. Connect the data cable to the upper PCA and the mid-point connector.
13. Set the outrigger tube at its mounting position and fasten it with the seven bolts removed in step 4. Tighten the clamp bolts loosened in step 5.
14. Replace the display bracket cover with the hardware removed in step 2.
15. Set the on/off switch in the on position and thoroughly test the EFX per Section Four.

Procedure 7.23 - Replacing a Ramp Mounting Bracket

Warning: Care must be taken when work is being performed in the area of the stairarms. Pinch points exist between the stairarm and ramp and between the stairarm and crankarm, when the rear covers are removed.

Procedure

1. Raise the incline to its maximum position.
2. Set the on/off switch in the "off" position, then unplug the power cord from the wall outlet.
3. Place a support (such as a piece of wood) between the rear of the ramp and the frame. the support must fit snugly so that it will support the ramp when the ramp mounting bracket is removed. The support will also facilitate the mounting and alignment of the replacement ramp mounting bracket.
4. Remove the four screws that fasten the ramp mounting bracket to the ramp.

Diagram 7.26 - Ramp Mounting Bracket



5. Remove the two large bolts that fasten the ramp mounting bracket to the frame.
6. Set the ramp mounting bracket at its mounting position and fasten it to the frame with the hardware removed in step 5. Torque the bolts to 480 inch pounds (40 foot pounds).
7. Fasten the ramp mounting bracket to the ramp with the hardware removed in step 4, torque the screws to 144 inch pounds (12 foot pounds).
8. Remove the support from the rear of the ramp.
9. Thoroughly, test the EFX per Section Four.

Procedure 7.24 - Replacing a Power Entry Module Fuse

Procedure

1. Set the on/off switch in the off position. Remove the A.C. line cord from the A.C. outlet and from the power entry module.
2. Using a thin bladed screwdriver, carefully pry the fuse access door open.
3. Using a thin bladed screwdriver, carefully pry the fuse module out of the power entry module.
4. The fuse module contains two fuses, carefully remove one or both fuses out of the fuse module, as required.
5. Insert the replacement fuse(s) into the fuse module. Use only 2 amp time delay fuses.
6. Slide the fuse module back into the power entry module and close the fuse access door.
7. Insert the A.C. line cord in the power entry module and the A.C. outlet.

Diagram 7.27 - Power Entry Module Fuse

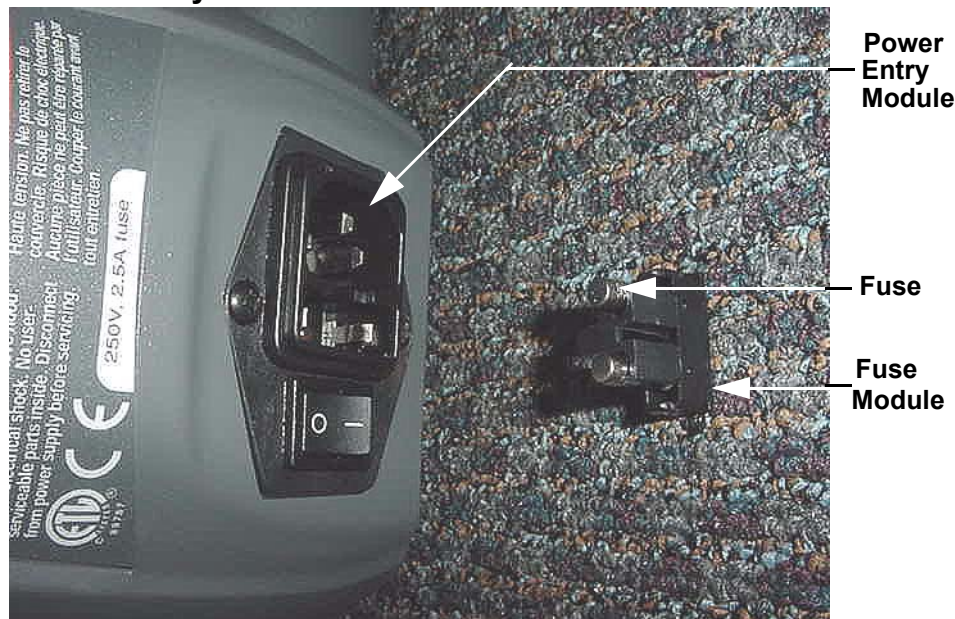

8. Set the on/off switch in the on position and test the EFX per Section Four.

Procedure 7.26 - Replacing a Lift Motor

1. Set the on/off switch in the “off” position. Remove the A.C. line cord from the A.C. outlet.
2. Remove the upper and lower front covers per Procedure 7.21.
3. Remove the bolts that fasten the upper end of the ramp to the lift motor yoke. See Diagram 7.15.
4. Carefully, draw the lift motor yoke out of the ramp and lay the ramp down against the frame.
5. Disconnect the lift motor connector and remove the screw that retains the lift motor frame ground. See Diagram 7.28.

Diagram 7.28 - Lift Motor Mounting

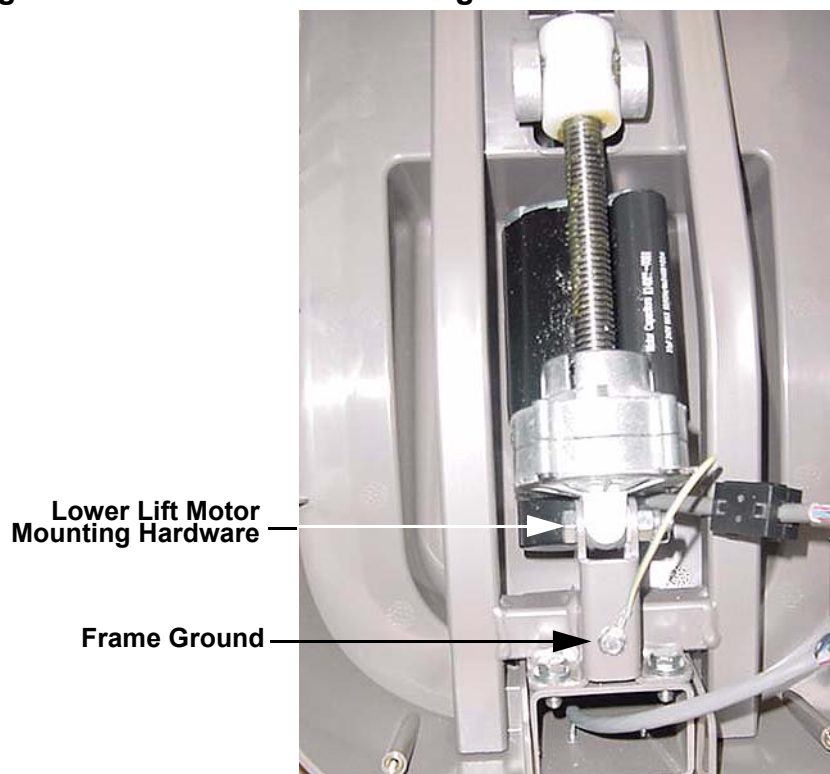

6. Disconnect the lift motor cable connector.
7. Remove the nut and bolt that fasten the lower end of the lift motor to the frame.

8. Thread the lift motor yoke onto the replacement lift motor.
9. Set the replacement lift motor in its mounting position and secure it with the nut and bolt removed in step 7, torque the bolt to 60 inch pounds.
10. Reconnect the lift motor cable connector. Fasten the frame ground connector to the frame with the screw removed in step 6, torque the frame ground screw to 90 inch pounds.
11. Calibrate the lift motor per Procedure 5.3.
12. Raise the ramp and slide the lift yoke into the ramp and fasten it with the hardware removed in step 3.
13. Replace the lower and upper front covers.
14. Thoroughly, test the EFX per Section Four.

Procedure 7.27 - Replacing the PROM

1. The PROM and the associated printed circuit assembly (PCA) are static sensitive. Anti-static devices must be used and all anti-static precautions must be followed during this procedure.
2. Remove the printed circuit assembly per its associated procedure.
3. The prom is a forty-four pin square package (PLCC44). This prom should be removed with a proper IC removal tool (see the illustration below)

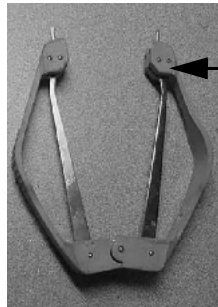

PLCC44 removal tool

4. The IC's may inserted into their socket by hand by carefully aligning the notch on the IC with the notch on the IC socket and carefully pressing the IC into its socket. See the illustrations below for the alignment notches. Care must be taken that the IC legs on a DIP28 are all aligned in the socket to prevent the legs from bending when inserted. The PLCC44 IC must be carefully aligned squarely in its socket or it will not insert. Do not force the IC into its, socket. If it does not insert easily, remove the it and re-align it in its socket.

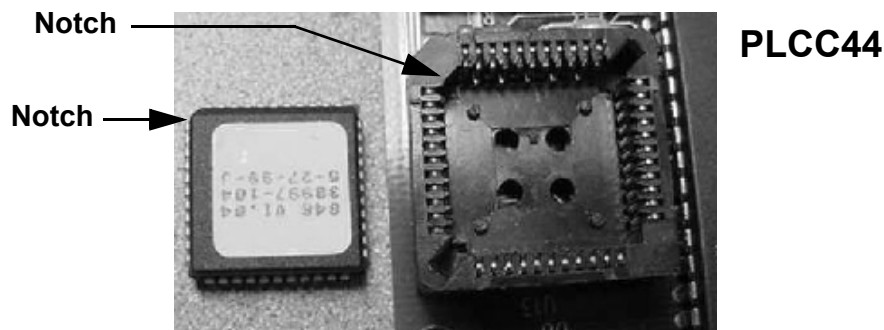

Procedure 7.28 - Incline Yoke Replacement

1. Plug the EFX's A.C power cord into an A.C. outlet and set the on/off switch in the "on" position.
2. Raise the incline to its highest position (level 20).
3. Set the on/off switch in the "off" position and remove the EFX's A.C. power cord from the A.C. outlet.
4. Remove the front cover per Procedure 7.21.
5. Note the number threads above the incline yoke nut or measure the distance from the top of the incline yoke nut to the top of the incline motor's drive screw. The replacement incline yoke will need to be installed in the exact same position as the existing incline yoke. See Diagram 7.29.

Diagram 7.29 - Incline Yoke Nut Position

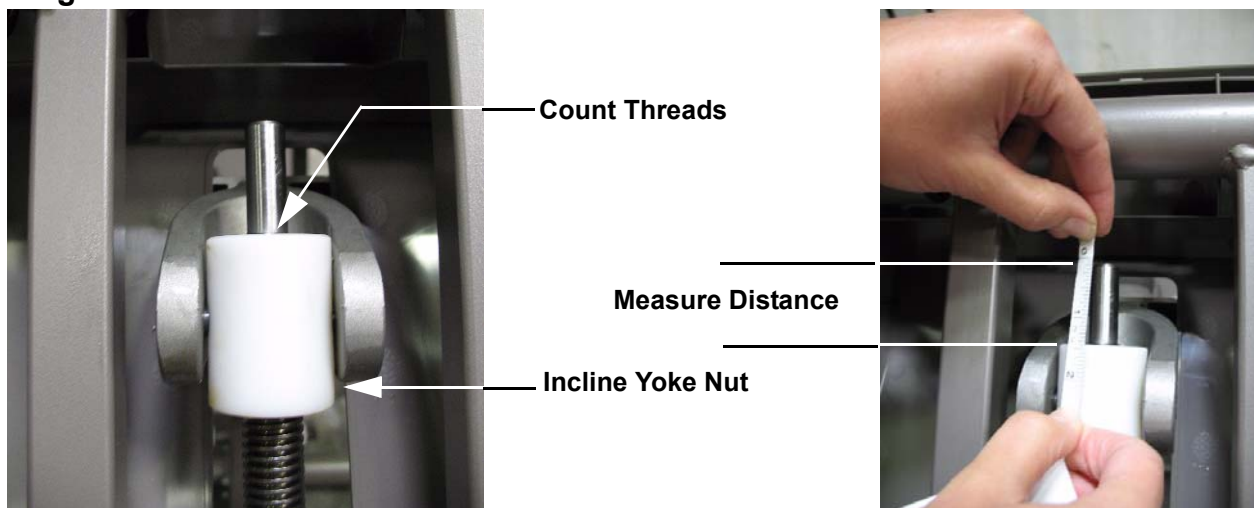

6. Remove the upper ramp mounting bolts, that fasten the incline yoke to the ramp. See Diagram 7.15.
7. If two people are available, have your assistant straddle the ramp and support it while you slide the incline yoke out of the ramp. If you do not have two people available, straddle the ramp and support it with one hand and slide the yoke out of the ramp with your other hand. See Diagram 7.30.
8. Move the incline motor forward so that it rests on the EFX's frame and carefully lower the ramp onto the lower portion of the plastic cover.

Diagram 7.30 - Removing the Yoke from the Ramp



9. Note the orientation of the incline yoke, the replacement yoke must be installed in the same orientation. If the replacement yoke is installed upside down the incline will go too low and damage the cover. See Diagram 7.31.
10. Taking care to not allow the incline motor's drive screw rotate, thread the incline yoke off of the incline motor's drive screw. If the incline motor's drive screw rotates, the incline motor will need to be calibrated per Procedure 5.3.

Diagram 7.31 - Incline Yoke Orientation



11. Taking care to not allow the incline motor's drive screw rotate, correctly orient the replacement incline yoke and thread it onto the incline motor's drive screw until it is in the same position as noted in step 5. If the incline motor's drive screw rotates, the incline motor will need to be calibrated per Procedure 5.3.

12. Raise the ramp and slide the yoke into the ramp. Secure the yoke with the hardware removed in step 6.
13. Replace the front cover per Procedure 7.21. Thoroughly, test all EFX functions paying special attention to all incline functions.

Wiring Diagram 8.1 - 5.31, 5.33, 5.35, 5.37 EFX

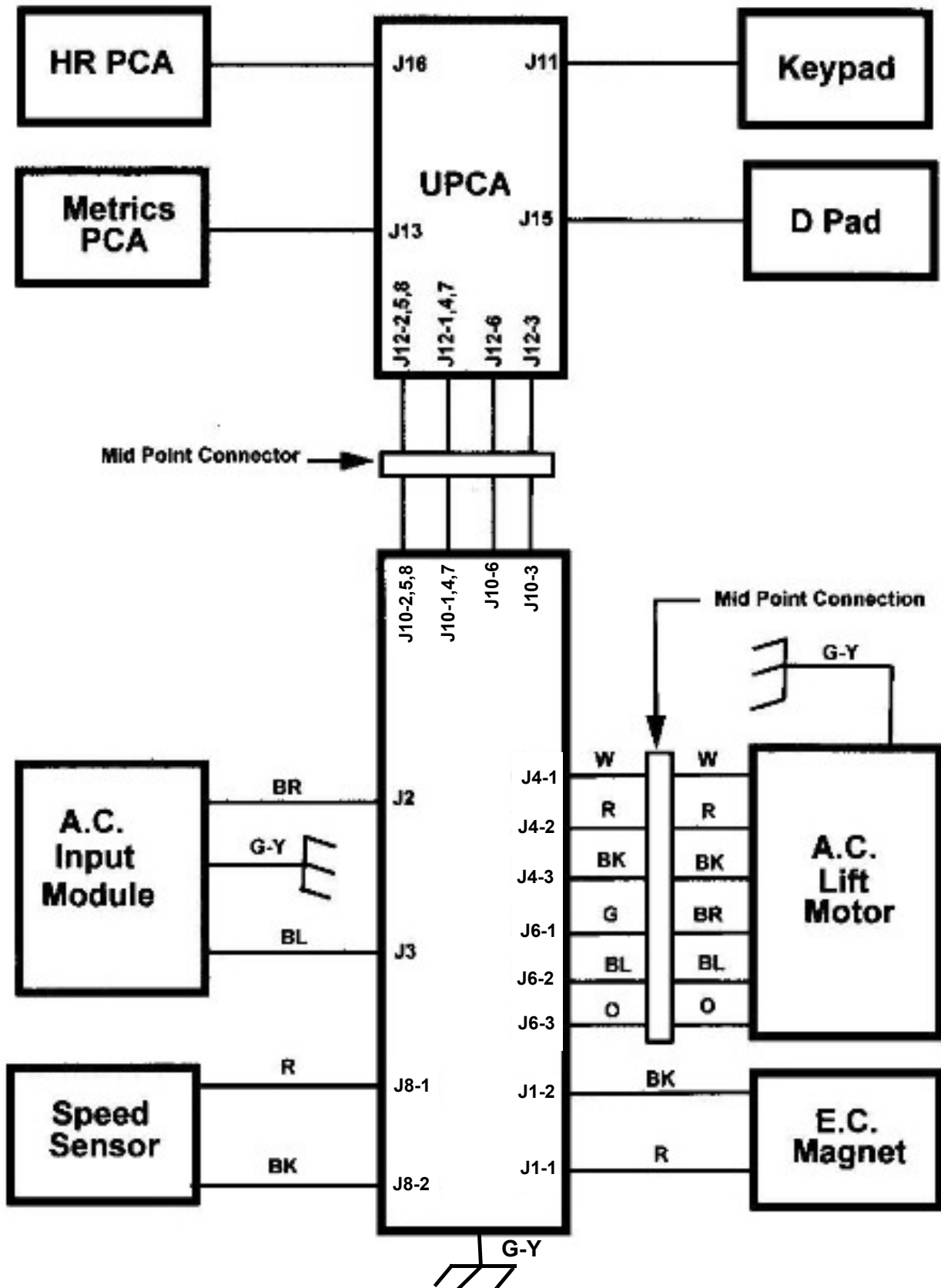

Block Diagram 8.2 - 5.31, 5.33, 5.35, 5.37

5.31, 5.33, 5.35, 5.37 EFX

